

O-16

WHEREAS, the Union Township Board of Education obtained pricing for the replacement of copiers throughout the District. These copiers can be networked for use as printers and scanners; and

WHEREAS, Atlantic Business Products provided us with a proposal under the State contract # 40467 for Savin Copiers in the amount of \$9,058.00 per month for 60 months for 39 machines and a cost of \$.004 for Black and White copies (which includes all service, parts, labor and toner) and

NOW THEREFORE BE IT RESOLVED; that the Township of Union Board of Education enter a contract with Atlantic Business Product for a 60 month period starting 09/2017 ending 09/2022

Dated: June 20, 2017

Gregory E. Brennan
Board Secretary



Atlantic
tomorrowsoffice.com



**Proposal for
UNION TOWNSHIP BOARD OF EDUCATION
June 13, 2017**

**Recommendation Submitted by:
Atlantic - Tomorrow's Office
Al Figalora
400 Broadacres Drive; Suite 250
Bloomfield, NJ 07003
Cell #908-656-5390
afigalora@tomorrowsoffice.com
www.tomorrowsoffice.com**



Gregory Brennan
Business Administrator
Union Township Board of Education
2369 Morris Ave
Union, NJ 07083-5712

Dear Gregory:

Thank you for the opportunity to provide you with an Office Automation Solution for Union Township Board of Education.

As you may know, Atlantic Tomorrow's Office (Atlantic) is the region's leading vendor supplying public sector institutions with document management equipment. We know the needs of the public sector environment from documents to electronic files and work diligently to make sure our clients have the needed equipment to function on a daily basis. In today's economy we realize how important it is to have a vendor you can count on, a vendor that will work with you during all phases of your document workflow. We believe we have always strived to serve the needs of all of our clients and hope to meet the needs of Union Township Board of Education as well. At Atlantic, we work with our clients to provide a methodology that offers leading edge solutions while being very cost conscious. Solutions like this are not new to Atlantic, we have been doing so for over 50 years and a solid repeat client base (over 400 K-12 institutions) tells us we are making the right recommendations for our clients. Solutions that we recommend come from understanding our client's needs and offering world class solutions that can be implemented across your enterprise with outstanding results.

Please review the enclosed and I believe you will see how we work with our clients and the tools we use to provide cost saving solutions while increasing employee productivity.

At Atlantic we offer programs that carry out execution of recommendations and follow up that insures that we deliver what we promise. Atlantic works with many partners to deliver the right solution for our clients. Partners such as Microsoft, Toshiba, Ricoh, Savin, Konica Minolta, Kyocera/Mita, HP and Cube Pro 3D printers allow Atlantic to have the best solutions industry wide. After your review of the enclosed I am sure you will see that Atlantic offers our clients the best possible solutions as well as utilizing the most advanced tools and client service to keep our clients operating at peak efficiency.

Again, thank you for this opportunity to possibly serve Union Township Board of Education and provide you with a sensible solution to your document management needs.

Respectfully,

Al Figalora

Al Figalora
Government Sales Account Manager
Atlantic Tomorrow's Office

Atlantic Tomorrow's Office History

A Little History

Atlantic Tomorrow's Office was founded in 1959 as Atlantic Photocopy. Through hard work and by taking great care of our customers, the Atlantic family has grown from a five person operation to a 240 employee corporation, supporting over 15,000 Organizations. We are currently Toshiba, Ricoh, Savin, Konica Minolta, Kyocera & HP authorized resellers, and are one of the largest independent office technology companies in the United States. Atlantic is an Office Technology and IT Solutions Company (VAR) providing horizontal nice market services to small and large corporations in the Tri-State area. Atlantic offerings include: Imaging, IT Support, Document Management, and Managed Services.

What Makes Us Different?

Atlantic's Seal of Satisfaction – We lay out our commitment to our customers in black and white not just with comforting words. The Seal of Satisfaction lists such items as guaranteed response time on service calls, loaner programs, and replacement programs. Our President's phone number is listed on the Atlantic Seal of Satisfaction as well to ensure that we live up to our high standards and you receive the service that you deserve. [Attached is Seal of Satisfaction]

As firms today accomplish due diligence in every aspect of purchasing best practice solutions, they look for vendors who can accomplish many tasks under one consultative umbrella. We at Atlantic understand and embrace this philosophy. Over the past few years we have researched additional practice areas that would make us a stronger resource to our clients and prospects. Below please find a listing and a description of our Managed Services. We are Atlantic Tomorrows Office with the power of one stop shopping for your document needs from creation to final disposition. We are more than a copier company, and here is why:

Service hours of operation

ATLANTIC will have service contacts available from 7:00 am to 6:00 pm Monday thru Friday. ATLANTIC offers one central "800" telephone number for all service calls. Our service response time is within 4 hours after receipt of notification.

Equipment and Supplies

ATLANTIC will provide all equipment requested and provide all supplies for all units under agreement with ATLANTIC. Equipment and supplies can be ordered through the World Wide Web via our client web portal, or by calling our toll free supplies telephone number. Al Figalora will be the primary account manager assigned to the Union Township Board of Education.

Billing Reports and Invoicing

At ATLANTIC we have found that client frustration with a vendor is not typically equipment or service related, rather frustrations arise from billing or invoice errors. To minimize this ATLANTIC will customize our invoices per the needs of the town. Typically prior to installation ATLANTIC will meet with our client, understand the needs and capture what our clients' desire for accurate billing. We feel that if we get the frame work correct the balance for the invoice is variable date which is collected automatically from the connected units so our billing/invoice issues are eliminated. ATLANTIC schedules account reviews to review our performance on a monthly or quarterly basis with our clients.

Implementation/Floor Plan layout

Prior to creating our implementation plan we typically meet with our client to review how our recommended solution will be laid out within their facility. We take special care in making sure that all areas have easy access to our units as to not waste valuable employee time. Once a floor plan layout is decided upon we can then create our implementation plan to insure all needed areas are addressed such as, electrical, space and ventilation requirements are provided for to insure proper performance of our recommended solution

Atlanticare^{rim}

Records and Information Management

Since September 11, 2001, Regulatory Compliance issues to ensure a firm's Vital Records are available in case of a disaster have come to the forefront. Disaster Recovery/Business Continuity Programs are now considered mandatory for all firms doing business today, regardless of vertical market or doing business in the public or private sectors.

Atlanticare RIM's practice area provides legally sufficient best practice consulting services to ensure record keeping regulatory compliance. Our services include Records Retention Schedule and Policy and Procedures Development, Vital Records Programs and Disaster Recovery/Business Continuity modules. Records Management-trained Teams can also provide implementation of said Programs such as legally sufficient purge and destruction campaigns, industry-driven document audits, staff training, etc.

Atlanticare^{mps}

Managed Print Services

Office printing costs are the most under managed expense in corporate America today. In fact, Gartner statistics show that 1%-3% of annual corporate revenues are spent on printing costs. In addition, IDC research demonstrates that few firms realize the magnitude of their spending on document production, distribution, storage, retrieval and document/content repurposing. Atlanticare's MPS practice area can help address each of these areas to help create efficiencies and reduce costs.

The Atlanticare MPS Program is a scalable, end-to-end managed print solution that provides automation creating efficiency to help drive down cost and allow you to focus on your business, not your print devices. Key features to this solution include just-in-time supplies inventory, preventative and proactive maintenance, levels 1 and 2 triage support, CPP billing, automated meter collection and a dedicated MPS fleet consultant.

Atlanticare^{dms}

Document Management Solutions

Another major issue for firms today is staff having access to their own mission critical data. Unfortunately, seven out of ten office workers state they find it easier to locate other information rather than their own! In addition, data needs to be accessed in an expeditious and targeted manner that is totally secure. In today's "doing more with less" economic climate, document management is simplified utilizing Atlanticare DMS' tools coupled with best practice experience. "Green" initiatives and document security also come into the forefront with Document Management's inherent backup solutions.

Atlanticare^{it}

IT Managed Services

The major issues firms state they have when engaging IT support organizations are unpredictable and uncontrolled IT spending. Atlanticare's Managed IT system protects your budget by offering service and billing based on a fixed monthly cost. In addition, our quarterly CIO reviews assist in planning for the rest of your fiscal year, and our fluid business model allows us to maintain a quality level of service while your business changes throughout the year. Immediate cost savings are demonstrated by Atlanticare IT solutions with our efficient on boarding process. Complex IT systems are summarized to an executive level giving our Clients immediate insight into otherwise uncertain technological decisions.



Our Process

Create digital output architecture with digital multifunction device (MFD) as the departmental hub for document distribution.

Opportunity

- **Migrate costs** from more expensive output devices to the digital MFD platform.
- **Increase staff productivity** by allowing users to send jobs directly to the MFD for printing and copying of single or multiple documents.
- **Reduce administrative overhead** on IT for printing
- **Standardization and consolidation** reduces multiple supplies, invoices separate user interfaces
- **Provide cost incentive** for sending large jobs to the copy centers rather than tie up Clark Board of Education labor on smaller machines.

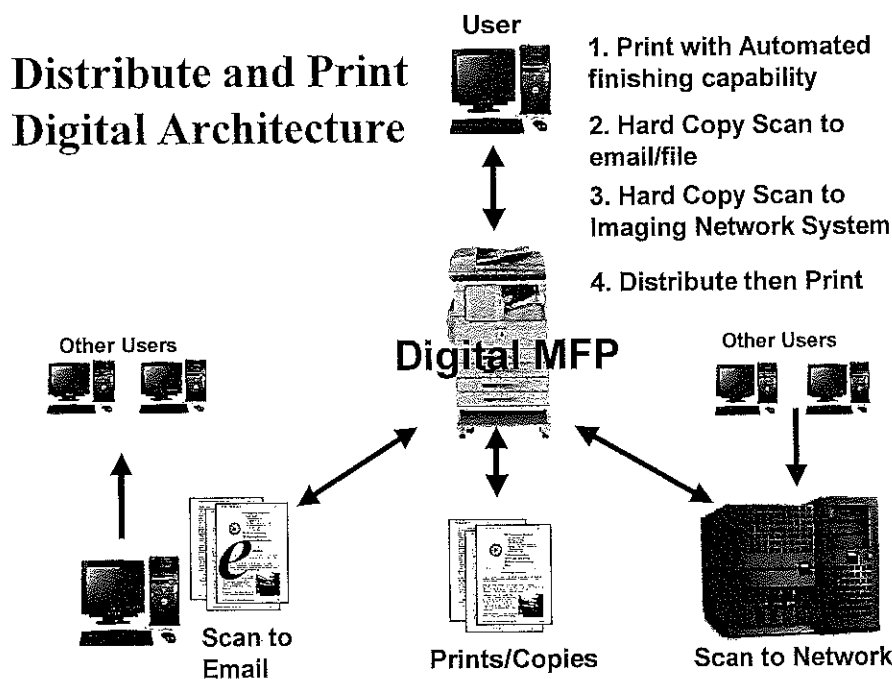



Benefits of doing business with Atlantic Tomorrow's Office:

- 1. Many similar references including: Union County Votech, Summit Board of Ed, Rahway Board Of Ed, Hillside Board Of Ed, Westfield Board Of Ed, Mountainside Board Of Ed, Garwood Board Of Ed**
- 2. Remote Installation = Plug & Play upon delivery:
all IP addresses, settings, etc. are done remotely
prior to delivery.**
- 3. Provide unlimited training & support from beginning to end at no
additional charge.**
- 4. We are an IT Solutions Company that can provide support Above &
Beyond the copiers: Document Management & Records Retention,
Managed IT Services, Professional Services, and Managed Print
Services.**
- 5. We are the largest copier provider to schools in New Jersey – we do
business with over 400 school districts in New Jersey (we know how
you work and do business – PO's, board meetings, no late fees, no
insurance fees, non-appropriation clauses in our lease, etc.)**
- 6. We are on the New Jersey State Contract = Ease of Procurement.**
- 7. We have many PaperCut References including.**
- 8. We have been awarded the 2014 Elite Copier Dealer Award.**
- 9. Union County Votech awarded us the 2014-2015 Business Partner of the
Year.**
- 10. We won the NJASBO "2009 Above and Beyond Award".**
- 11. We are a member vendor of Union County and New Jersey Association
of School Business Officials.**
- 12. Al Figalora has over 20 years of experience servicing school districts in
Union County – he has knowledge, consistency & experience.**

Atlantic / Union Township Board of Education - Partnership Plan

With an Atlantic agreement, we form a partnership that is based on a strong commitment to serving you in the best ways possible. We do everything we can to make our business relationship a very positive experience for everyone involved.

AS PART OF OUR PARTNERSHIP PLAN, WE WILL OFFER A SOLUTION THAT ADDRESSES THE FOLLOWING AREAS:

- *Performance Standards*
- *Training*
- *Service Hours of Operation*
- *Equipment/Supplies*
- *Billing Reports/Invoicing*
- *Floor Plan /Layout*

Performance Standards

Performance Standards will be developed that will enable Atlantic and the Union Township Board of Education to develop standards as a guideline for future process improvement. Performance Standards will be reviewed on a monthly or quarterly basis during our account review process.

Standard	Measurement	Method	Frequency
4 Hour response time	Service Reports	Measure response time from initial service call	Quarterly
Correct Invoice	Atlantic Invoices	Compare invoice against actual meter readings	Quarterly

Training

Our recommendation includes a full training session for all employees so they are proficient in all areas of equipment usage including but limited to; automatic stapling, adding toner, one and two sided copying/printing, paper cassette selection , cover and sheet insertion.

Union Board Education

School	Dept	Model	SN#	Meter Read	Avg Monthly Volume	Lease Cost	Proposed Model	Lease Cost
High School	Copy Room	Ricoh 8110	E814C660002	3,712,162	119,747	\$14,378.18	Savin 8210	\$9,058.00
High School	Copy Room	Ricoh 8110	E814C660042	4,094,203	132,071	Included	Savin 8210	Included
High School	Attendance	Ricoh 3053	E754L950028	88,756	2,863	Included	Savin 3055	Included
High School	Sports Dept	Ricoh 4002	W524L901273	249,024	8,033	Included	Savin 4055	Included
High School	Cast Office	Ricoh 3053	E754L850668	53,733	1,733	Included	Savin 4055	Included
High School	D211	Ricoh 3053	E754L950037	32,188	1,038	Included	Savin 3055	Included
High School	Main	Ricoh 3053	E754L850483	107,907	3,481	Included	Savin 3055	Included
High School	Graphic Arts	Ricoh 3053	E754L850684	33,963	1,096	Included	Savin 3055	Included
High School	D215	Ricoh 3053	E754L850670	45,085	1,454	Included	Savin 3055	Included
Hannah Caldwell	Main Office	Ricoh 5002	W533G900028	245,855	7,931	Included	Savin 5055	Included
Hannah Caldwell	2nd Fl Copy Room	Ricoh 8100	E804C760134	2,411,846	77,801	Included	Savin 8200	Included
Hannah Caldwell	Copy Room	Ricoh 8100	E804C760086	2,480,421	80,014	Included	Savin 8200	Included
Administration	Transportation	Ricoh 5002	W533G800141	144,081	4,648	Included	Savin 5055	Included
Administration	Maintenance	Ricoh 5002	W534G500062	220,134	7,101	Included	Savin 5055	Included
Administration	Superintendent	Ricoh 7502	W874L300471	189,543	6,114	Included	Savin 7503	Included
Administration	Business	Ricoh 7502	W874L300444	416,971	13,451	Included	Savin 7503	Included
Washington	Media Center	Ricoh 6002	W864L900428	1,120,089	36,132	Included	Savin 6503	Included
Washington	Library	Ricoh 6002	W864L900423	1,210,496	39,048	Included	Savin 6503	Included
Washington	1st Floor PTA	Ricoh 5002	W534G500054	573,432	18,498	Included	Savin 5055	Included
Washington	Main Office	Ricoh 4002	W524L901287	436,791	14,090	Included	Savin 4055	Included
Franklin	Conference	Ricoh 4002	W524L901270	472,652	15,247	Included	Savin 4055	Included
Franklin	Teachers Lounge	Ricoh 7502	W874L300467	670,581	21,632	Included	Savin 6503	Included
Franklin	Teachers Lounge	Ricoh 6002	W864L900380	1,097,589	35,406	Included	Savin 6503	Included
Kawameeh	Main Office	Ricoh 5002	W534G500009	259,235	8,362	Included	Savin 5055	Included
Kawameeh	Copy Room	Ricoh 8110	E814C660003	2,235,798	72,123	Included	Savin 8200	Included
Livingston	Teachers Lounge	Ricoh 7502	W874L300422	1,700,177	54,844	Included	Savin 7503	Included
Livingston	Library	Ricoh 6002	W864L800912	688,850	22,221	Included	Savin 6503	Included
Connecticut Farms	Copy Room	Ricoh 7502	W874L300428	1,863,767	60,122	Included	Savin 7503	Included
Connecticut Farms	Child Study Team	Ricoh 3053	E754L950024	41,000	1,323	Included	Savin 3055	Included
Jefferson	Main Office	Ricoh 7502	W874L300425	561,303	18,107	Included	Savin 6503	Included
Jefferson	Teachers Lounge	Ricoh 7502	W874L300415	1,494,300	48,203	Included	Savin 7503	Included
Jefferson	Copy Room	Ricoh 8100	E803C860086	2,045,844	65,995	Included	Savin 8200	Included
Burnett	Library	Ricoh 7502	W874L300466	1,048,459	33,821	Included	Savin 6503	Included
Burnett	Library	Ricoh 7502	W874L300457	1,025,187	33,071	Included	Savin 6503	Included
Burnett	Library	Ricoh 3053	E754L850660	34,425	1,110	Included	Savin 3055	Included
Burnett	Copy Room	Ricoh 8110	E814C660024	4,360,992	140,677	Included	Savin 8210	Included
Hamilton	Supervisors	Ricoh 5002	W533G400039	271,556	8,760	Included	Savin 4055	Included
Hamilton	Special Services	Ricoh 8110	E814C660023	447,717	14,442	Included	Savin 6503	Included
High School	IT Department	Ricoh 2852	W422L500466	36,129	1,165	\$155.18	Savin 3055	\$9,058.00
					1,232,976	\$14,533.36	1,235,000 x \$.004	\$4,940.00
							Total Monthly Cost	\$13,998.00
							Total Monthly Savings	\$535.36

\$.004 includes all service and supplies (except paper and staples)

Includes remaining payments of Ricoh leases as of September 2017 and return equipment back to leasing company.



Proposed Products



**Savin MPC 7503,
6503**

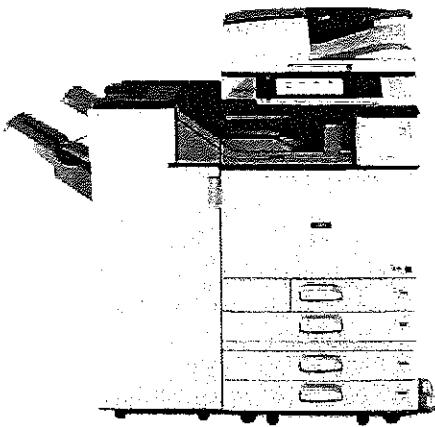

**Savin MP 3055,4055,
5055**

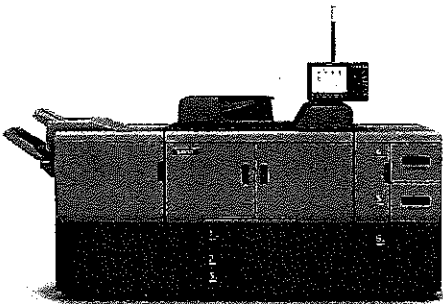

**Savin PRO
8200/8210**

SAVIN®

MP 2555
MP 3055
MP 3555

Multifunction B&W

- Copier
- Printer
- Facsimile
- Scanner

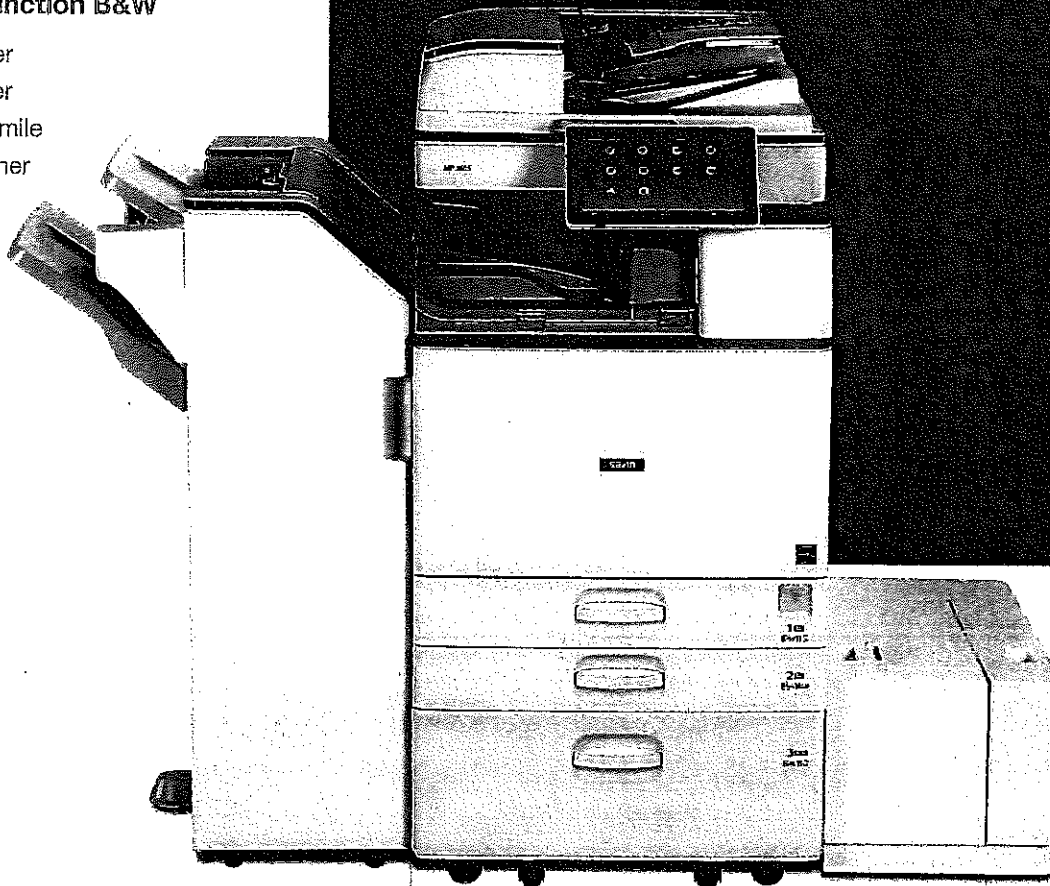

MP 2555

25 ppm
monochrome

MP 3055

30 ppm
monochrome

MP 3555

35 ppm
monochrome

Turn the everyday into an easy day

There are no easy answers. But at least there's an easy way to share the answers you have. Use the SAVIN® MP 2555/MP 3055/MP 3555 to simplify everyday office tasks and move information to the people who need it most, in the format they prefer. Print and copy important business-class presentations and proposals and choose between multiple internal and external finishers for a professional, polished look. Scan full-color images, brochures and other forms and distribute them instantly. With the same pinch-and-flick and scrolling gestures you use on your smartphone or tablet, you can access critical information, set shortcuts and distribute information from the advanced 10.1"-wide Super VGA Smart Operation Panel. Or, connect remotely and work on the go. Take advantage of advanced security controls to help protect your data wherever it goes, from wherever you are.

- Print up to 35 prints/copies per minute for productive black-and-white output
- Use intuitive touchscreen controls to copy, print, scan and fax quickly
- Create your own workflows with shortcuts to simplify tasks
- Access, print and distribute information from your personal mobile device
- Minimize energy costs via a wide range of innovative eco-friendly features
- Produce professional-looking saddle-stitched and punched booklets, presentations and proposals
- Simplify sorting and stapling tasks with compact internal and high-output external finishers
- Toggle between stapled or stapleless finishing automatically with an external hybrid 1,000-sheet finisher



Add value to everything, everywhere

Enhance multifunction productivity effortlessly

Get the word out quickly

When sharing information, on-time delivery leads to on-the-money decisions. Use one-touch controls on the MP 2555/MP 3055/MP 3555 to print black-and-white notes, reports, presentations and more at up to 35 pages per minute (ppm). Use the 100-Sheet Automatic Reversing Document Feeder (ARDF) or 220-Sheet Single Pass Document Feeder (SPDF) to scan black-and-white or full-color originals and distribute them digitally in an instant. Store up to 3,000 files on the embedded Document Server. Grab the one you need and print or send it immediately with fewer steps to save time. Add paper trays and expand total paper capacity to 4,700 sheets to minimize interruptions.

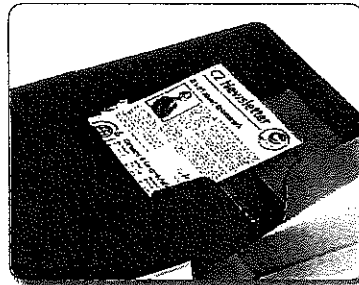

Work whenever, wherever

A great idea can come out of nowhere. The key is being able to send it somewhere. Simply download the Smart Device Connector app on your Android™ or iOS® devices to share information and print without printer setup configurations or utilities. Connect your Android and iOS devices with the MFP via Bluetooth (BLE), or Android devices using the Near Field Communication (NFC) tag. Grab information directly from cloud storage applications, such as Google Drive™, Box™ or Dropbox™, and print it using the Smart Device Connector app. Plus, you can now print emails and attachments with the latest version (v3.0) of the app. Scan originals at the MFP and send them to your personal device or directly to cloud storage, so you can access or distribute them digitally at your convenience. Printing from AirPrint® is also available.

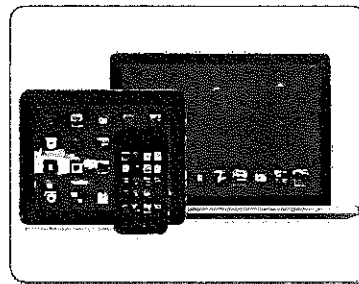

Compel with quality

It's not a good look when your message goes unnoticed. Use the MP 2555/MP 3055/MP 3555 to impress audiences with sharp images and precise text at up to 1200 x 1200 dpi resolution in PC, Mac or Linux. Find important details and make changes quickly in fewer steps with the icon-driven drivers. For customers that require more complex work flows, these new devices now include standard PostScript to help improve productivity. With the 1.46 GHz Intel® based controller, you can handle your most complex printing and scanning tasks. Print on a wide range of paper types, from envelopes to cardstock to 11" x 17" sizes. Give output a new feel with thicker stocks up to 300 g/m². You can even create an easy-to-see poster from one of your current documents.

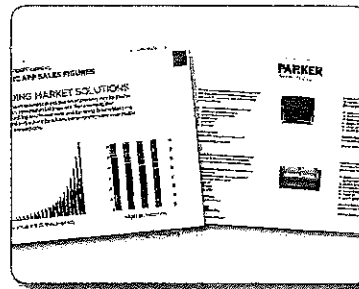

Speed up your workflow

Get in touch with productivity

Designed with Workstyle Innovation Technology, the customizable 10.1"-wide Smart Operation Panel uses your familiarity with today's touchscreen devices to provide a more intuitive user experience. Find the critical information you need quickly with the same pinch-and-flick, swipe scrolling and drag-and-drop gestures you use on your smartphone or tablet. All hard keys have been removed and information is displayed via easily identifiable icons in a grid-like interface. Customize the user interface with specific icons for important settings and features that you use regularly and perform specific tasks with a single touch. The MFP includes a web browser, so you can also print web pages, images and documents found online as PDFs.

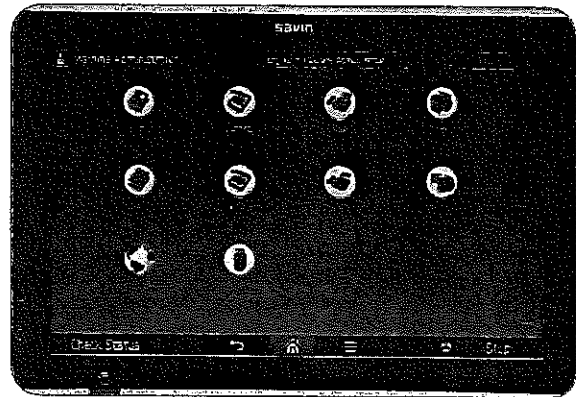

Use shortcuts to move ahead quickly

You know what you have to do. Now, you know how to do it faster. Customize your own automated workflows on the Smart Operation Panel and reduce repetitive manual steps that can impede the flow of information. Download easy-to-use workflow apps from our Application Site to add specific features or single-function capabilities to simplify how you perform everyday tasks. For example, you can download the Conference Concierge app for step-by-step instructions on how to create supporting materials in the right format for your next big event. Download the ID Card Scan & Copy app to scan two-sided originals onto one side of a sheet of paper. You can even download the How-to Videos app for quick, convenient tutorials to expedite troubleshooting and customization tasks.



Integrate with fast, easy workflows

Your office does everything. But does everyone know how to do it? Simplify even the most complex tasks by integrating the MP 2555/MP 3055/MP 3555 with workflow software. Automate document management workflows, improve printer security controls, track costs, issue chargebacks and much more. For example, you might handle hundreds of paper documents every day. Use GlobalScan™ NX to reduce manual touch points, so you can convert them into digital files and route them around the globe in only moments. You can even use device management software, such as Streamline NX®, for centralized one-source control to expedite document management tasks for your entire fleet.



Turn your best ideas into immediate action

Scan and share critical information

Make real productivity gains in real time with a wide range of scanning capabilities. Convert hardcopy documents and images into digital PDF, JPG or TIFF files and share them instantly via multiple Scan-to capabilities. Even your most complex and graphics-intensive files can be compressed, so you can send them without delays or image degradation. With optional Optical Character Recognition (OCR) scanning, you can create PDF files that can be searched for by keywords. Use Distributed Scan Management (DSM) to simplify scanning for your entire organization. Set user permissions, assign rules and customize delivery preferences to automate and expedite everyday scanning tasks.

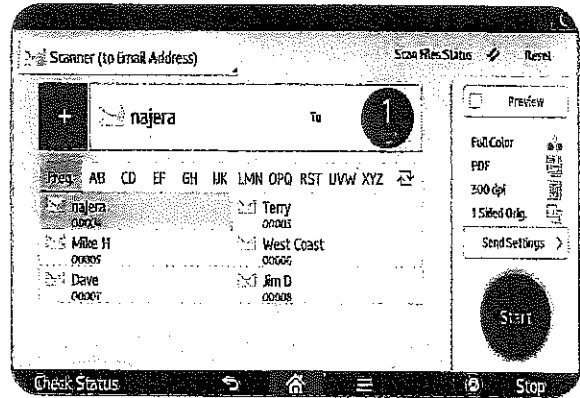

Cut your costs and environmental impact

Saving money should always be part of the plan. That's why we designed the MP 2555/MP 3055/MP 3555 with a wide range of sustainable, eco-friendly features. It is ENERGY STAR® certified and meets EPEAT® Gold criteria* to help reduce your environmental footprint. You can also schedule the MFP to power down when the office is empty and reduce paper costs with default duplex printing.

*EPEAT Gold rating is applicable only in the USA.

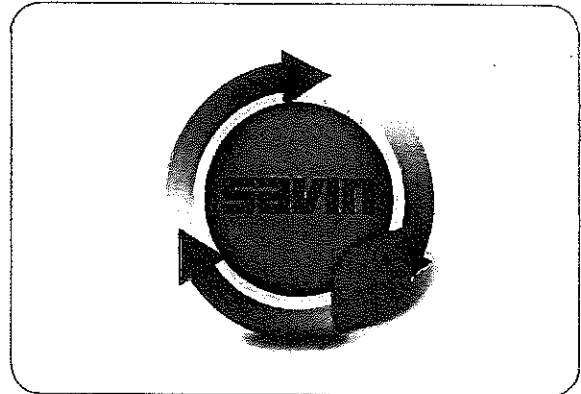

Keep tabs on your best people and ideas

A misplaced idea can turn into a missed opportunity. Protect information with a wide range of security controls. With user authentication, users have to log in to the MFP to gain access to information and controls. Have them enter a passcode, billing code or swipe an ID card with the optional NFC or HID card readers. You can track each user and see what they print and distribute. With Locked Print, jobs are held until the user releases them via authentication. Worried about excessive printing? Set print quotas. Want to charge departments for print usage? Add optional accounting software, such as Device Manager NX Accounting, to issue chargebacks. The hard disk drive offers powerful encryption protection. The built-in DataOverwriteSecurity System (DOSS) overwrites latent images remaining on the hard drive.

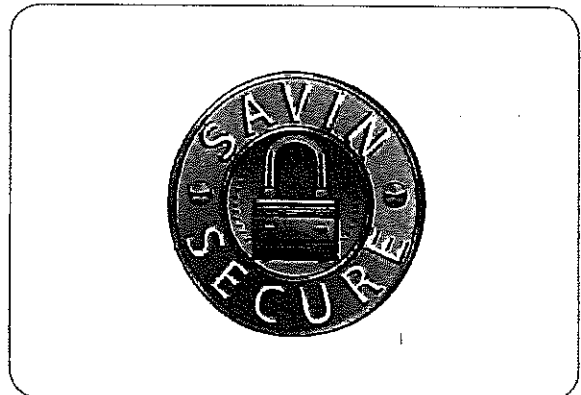

To view detailed features of our multifunction products online go to www.savin.com/products

Make big productivity gains in small offices

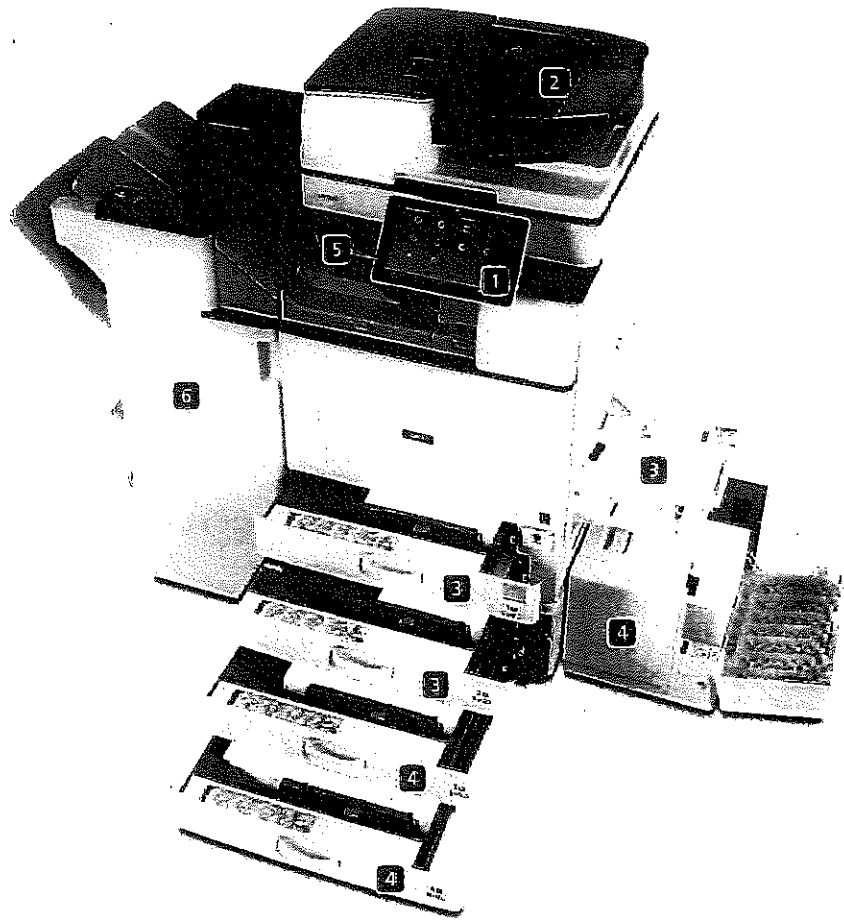

- 1 Full-Color 10.1"-Wide Super VGA Smart Operation Panel:** Navigate between jobs and tasks with precise fingertip control. Use the same pinch-and-flick and swipe scrolling gestures you use on your smartphone and tablet to access menus, check settings and initiate jobs effortlessly.
 - 2 Automatic Reversing Document Feeder:** Load up to 100 single-sided or double-sided color or black-and-white originals for fast and easy scanning, copying and faxing.
 - 3 Standard Paper Trays:** Load up to 1,200 sheets of paper — up to 11" x 17" — with two 550-Sheet Paper Trays and the 100-Sheet Bypass Tray.
 - 4 Additional Paper Storage (Optional):** Add the 2,000-Sheet Tandem Large Capacity Tray and 1,500-Sheet Side Large Capacity Tray to expand paper capacity up to an incredible 4,700 sheets for longer, uninterrupted print runs. Or, use the optional 1 x 550-Sheet Paper Tray or 2 x 550-Sheet Paper Tray for multiple paper sources on demand.
 - 5 Document Retrieval:** Separate output for easy retrieval even in the busiest offices with the optional 125-Sheet One-Bin Tray and the 250-Sheet Internal Shift-Sort Tray.
 - 6 Document Finishing:** Produce professional documents to minimize outsourcing. Design your own complete document production solution with optional finishers, including a 1,000-Sheet Booklet Finisher, 500-Sheet Internal Finisher and 250-Sheet Internal Stapleless Finisher. With the 1,000-Sheet Hybrid Staple + Stapleless Finisher, you can choose between traditional automated staples, or stapleless output for up to five sheets of paper. This unique technology minimizes supply costs, simplifies paper shredding and offers a safer option for unique audiences such as schools and food manufacturing organizations.
- Single Pass Document Feeder (not shown):** The MP 2555/MP 3055/MP 3555 have Single Pass Document Feeder (SPDF) versions to help expedite scanning tasks. Load up to 220 single-sided or double-sided color or black-and-white originals in the SPDF for fast and easy scanning, copying and faxing.

Improve workflows in your small office or workgroup

Manage configurations, updates and more remotely

Expand productivity from one device to an entire fleet. Use Device Manager NX from any web browser to configure devices, add updates and monitor usage. Updating print drivers has never been easier. Simply install Device Software Manager and they'll update automatically. Use @Remote to collect meter readings automatically. You'll also receive automated service alerts, so you can react quickly when maintenance is required. Need technical assistance? You can download a series of How-To apps from our Application Site.

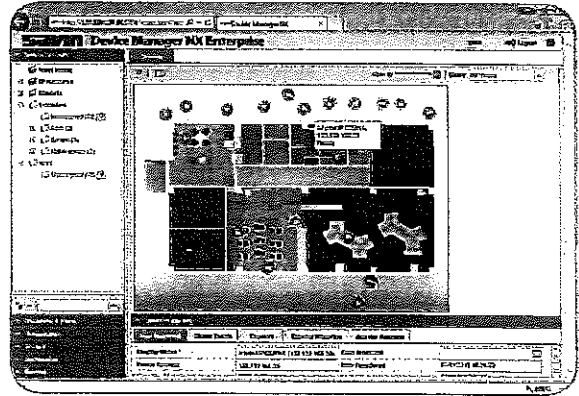

Engine/Copier Specifications

Configuration	Desktop
Scanning Element	One-Dimensional Solid Scanning Through CCD
Printing Process	Single Laser Beam Scanning & Electrophotographic Printing
Toner Type	Dry, dual component
Copy Resolution	600 x 600 dpi
Maximum Copy Quantity	Up to 999
First Page Out Time	4.6 seconds for MP 2555/MP 3055 4.3 seconds for MP 3555
Warm-Up Time	Less than 24 seconds
Recovery From Sleep Mode	7.9 seconds
Memory (Standard/Maximum)	2 GB RAM + 320 GB HDD (Shared)
Original Type	Book/Sheet/Object
Maximum Original Size	Up to 11" x 17"
B&W Print Speed (Letter/A4)	MP 2555: 25 prints/minute MP 3055: 30 prints/minute MP 3555: 35 prints/minute
Power Source	120V/60Hz/12A
Max. Power Consumption	Less than 1.6kW
Typical Electricity Consumption (TEC)**	MP 2555: 0.9 kWh/week MP 3055: 1.1 kWh/week MP 3555: 1.4 kWh/week
Standard Paper Capacity	1,200 sheets (550 sheets x 2 trays and 100-Sheet Bypass Tray)
Maximum Paper Capacity	4,700 sheets (w/Tandem LCT + Side LCT)
Supported Paper Types	Plain, Recycled, Colored, Special, Letterhead, Preprinted, Pre-punched, Bond, Cardstock, Envelope, OHP*, Label*
Supported Paper Sizes	Tray 1 & 2: 5.5" x 8.5" - 11" x 17" (A6 - A3) Bypass Tray: 5.5" x 8.5" - 12" x 18" (A6 - A3)
Supported Paper Weights	Tray 1 & 2: 16 - 80 lb. Bond (60 - 300 g/m) Bypass: 14 - 80 lb. Bond (52 - 300 g/m) Duplex: 14 - 68 lb. Bond (52 - 255 g/m)
Standard Output Capacity	500 sheets
Maximum Output Capacity	1,625 sheets (Bridge Unit + 1 Bin + 1,000-Sheet Finisher)
Document Feeder Type	Automatic Reversing Document Feeder (ARDF) Version or Single Pass Document Feeder (SPDF) Version
Document Feeder Original Size	5.5" x 8.5" - 11" x 17" (A5 - A3)

Document Feeder Paper Weight	Simplex 11 - 34 lb. Bond (40 - 128 g/m) Duplex: 14 - 34 lb. Bond (52 - 128 g/m)
Document Feeder Capacity	ARDF: 100 sheets, SPDF: 220 sheets
Preset Reduction & Enlargement Ratios	25%, 50%, 65%, 73%, 78%, 85%, 93%, 100%, 121%, 129%, 155%, 200%, 400%
Zoom Range	25% to 400% in 1% increments
Standard Features	Auto Paper Select, Auto Tray Switch, Photo Separation, Auto Start, Auto Off Timer, Booklet/Magazine Copy, Shift/Erase/Margin Adjustment, Combine (Layout), Cover/Chapter/Slip Sheets Insertion, Image Rotation, Document Server (3,000 File Capacity) with Folder Management and Password Protection, Web Browser, Duplex, Electronic/Rotate Sorting, 8 Job Presets, 25 Job Programs, Negative/Positive, Sample Copy, Series Copy, Simplified Display, 1,000 User Codes, Stamps/Numbering, Interrupt Copy, Login/Logout Button, System Reset Timer, Import/Export of Preference Settings, Eco-Friendly Indicator, Centralized Address Book Management
Dimensions (WxDxH)	23.1" x 25.9" x 35.9" (587 x 664 x 913 mm) w/ARDF 23.1" x 25.9" x 37.9" (587 x 664 x 963 mm) w/SPDF 156.5 lbs. (71 kg) w/ARDF 168.6 lbs (76.5 kg) w/SPDF
Weight	

*Bypass Tray only
**Typical electricity consumption by ENERGY STAR program

Printer Specifications (Standard)

Processor Speed	Intel® Atom Processor BayTrail-1.46 GHz
Connection Type	Standard on Device: 10Base-T/100Base-TX/1000Base-T Ethernet, USB Host Type A I/F (2 ports on back of device) Standard on Operation Panel: USB Host (Type A:1Port/Support USB Flash Memory), USB Host (Type A:1Port/Support optional Keyboard etc), USB Host Type Mini B and SD Card Slot Optional: IEEE 1284/ECP, IEEE 802.11b/g/n Wireless LAN

Network Protocols Supported Operating Systems	TCP/IP (IPv4, IPv6) Windows Vista/7/8/10, Server 2008/2008R2/2012/2012R2; Unix Filters for Sun Solaris 9/10, HP-UX 11.x/11i/v2/11v3, SCO OpenServer 5.0.7/6.0, Red Hat Linux Enterprise V4/V5/V6, IBM AIX 5L/V5.3/V6.1/V7.1, Mac OS X 10.7 or later, SAP R/3, IBM iSeries AS/400* using OS/400 Host Print Transform, Citrix Xen App 6.5 or later
Device Management Utilities	Web Image Monitor, Embedded @Remote, @Remote Office Appliance, @Remote Connector NX, @Remote Enterprise Pro, Device Manager NX Lite and Accounting, Device Manager NX Pro and Enterprise, Printer Driver Packager NX
Printer Languages	Standard: PostScript emulation, PCL5e/PCL6 Optional: Adobe® PostScript®3, XPS
Print Resolution Standard Features	Up to 1200 x 1200 dpi Sample/Locked/Hold/Scheduled/Store/Store and Print, PDF Direct Print, Mail to Print, Classification Code, Bonjour Support, Windows Active Directory Support, DDNS Support, PCL Resident Font Adoption, Tray Parameter Change from Web Image Monitor, 1200 dpi Support, Universal Driver, XPS Support, WS Printer, Media Direct Print (Print from USB/SD), Banner Page Print, Auto Job Promotion, Poster Print, WPS Support, Send to Document Server, Layout (N-up), Watermark, Slip Sheet, Rotate, Do Not Print Blank Pages, Dithering, Toner Saving, Black Over Print, User ID/Code/Authentication, Edge to Edge Print

Security Features (Standard)

Data Overwrite Security System (DOSS), Windows/LDAP/Basic/User Code/802.1x/Wired Authentication, Address Book/Authentication Password/SSL Communication/MIME/Post Communication/HDD/SMTP over SSL/TLS/Wireless LAN Encryption, Network Protocol On/Off, IP Filtering, Unauthorized Copy/Print Prevention, Quota Setting/Account Limit, Compulsory Security Stamp, HDD Encryption

Savin MP 2555/MP 3055/MP 3555

SYSTEM SPECIFICATIONS



Scanner Specifications (Standard)

Scan Speed (B&W & Full Color)	ARDP at 200/300 dpi: 79 ipm (Letter) ARDP at 200/300 dpi: 80 ipm (A4) SPDF at 200/300 dpi: Simplex - 110 ipm/ Duplex - 180 ipm (A4) Full Color & B&W: Up to 600 dpi TWIN: Up to 1200 dpi Up to 11" x 17"
Scan Resolution	Standard: 10Base-T/100Base-TX/1000Base-T Ethernet Optional: IEEE 802.11a/b/g/n Wireless LAN TCP/IP, SMB, SMT, POP, LDAP, FTP, IMAP4 Single and Multi-Page TIFF/PDF, High Compression PDF, PDF/A and Single-Page JPEG
Scan Area/Platen Size	Up to 11" x 17"
Connection Type	Standard: 10Base-T/100Base-TX/1000Base-T Ethernet Optional: IEEE 802.11a/b/g/n Wireless LAN TCP/IP, SMB, SMT, POP, LDAP, FTP, IMAP4 Single and Multi-Page TIFF/PDF, High Compression PDF, PDF/A and Single-Page JPEG
Protocol	Standard: 10Base-T/100Base-TX/1000Base-T Ethernet Optional: IEEE 802.11a/b/g/n Wireless LAN TCP/IP, SMB, SMT, POP, LDAP, FTP, IMAP4 Single and Multi-Page TIFF/PDF, High Compression PDF, PDF/A and Single-Page JPEG
File Formats	Standard: 10Base-T/100Base-TX/1000Base-T Ethernet Optional: IEEE 802.11a/b/g/n Wireless LAN TCP/IP, SMB, SMT, POP, LDAP, FTP, IMAP4 Single and Multi-Page TIFF/PDF, High Compression PDF, PDF/A and Single-Page JPEG
Standard Features	Embedded Scan-to-Email/Folder/SMB/FTP/ URL/PDF/A/Digitally Signed PDF, TWIN and Color Scanning, Auto Size Detection, Auto Density Selection, Image Rotation, SADF/Batch Mode, Mixed Size Mode, Reduce and Enlarge, Split Scan from Booklet Type Original, WS Scanner, LDAP Support, Preview Before Transmission, PDF Encryption, Drop Out Color Send, Distributed Scan Management

Fax Specifications (Optional)

Fax Option Type M29	PSTN, PBX
Circuit	ITU-T (CCITT) G3
Compatibility	200 x 200/100 dpi; 400 x 400 dpi (optional)
Resolution	MH, MR, MMR, JBIG
Compression Method	Up to 68 spm (Letter/A4)
Scanning Speed (LEF)	33.6 Kbps with auto fallback
Modem Speed	G3: 3 seconds per page (MMR Compression) G3: 2 seconds per page (JBIG Compression)
Transmission Speed	4 MB standard/64 MB maximum (320 pages/4,800 pages)
Max Auto Dials	2,000
Group Dials	100 (max. 500 numbers per group)
Standard Features	One Hour Backup, LAN-Fax Capability, Internet Faxing (I.F3), IP Faxing (I.3B), Fax Forwarding to E-Mail/Folder, Paperless Fax (HDD), Detection of Misplaced Document, Double-check of Destination Address, Direct SMT, LDAP Support, Universal Send (Simultaneous Fax and Scan), Fax Line Assignment, Fax Output Timer
Optional Features	Remote Fax, Simultaneous Operation of up to 3 lines

Optional Hardware Accessories

Paper Handling & Cabinet Options

One-Tray Paper Bank (PB3150/PB3250)**	Tray Capacity: 550 sheets x 1 tray Paper Size: 5.5" x 8.5" to 11" x 17" (A5 - A3) Paper Weight: 16 - 80 lb. Bond/166 lb. Index (60 - 300 g/m ²) Dimensions (WxDxH): 23.1" x 27" x 4.7" (587 x 685 x 120 mm) Requires installation of Caster Table Type M3
Two-Tray Paper Bank (PB3220)*	Tray Capacity: 1,100 sheets (550 sheets x 2 trays) Paper Size: 5.5" x 8.5" to 11" x 17" (A5 - A3) Paper Weight: 16 - 80 lb. Bond/166 lb. Index (60 - 300 g/m ²) Dimensions (WxDxH): 23.1" x 27" x 9.7" (587 x 685 x 247 mm)
Tandem Large Capacity Tray (PB3230/PB3260)*	Tray Capacity: 2,000 sheets (1,000 sheets x 2) Paper Size: 8.5" x 11" (A4) Paper Weight: 14 - 80 lb. Bond/166 lb. Index (60 - 300 g/m ²) Dimensions (WxDxH): 23.1" x 27" x 9.7" (587 x 685 x 247 mm)

Side Large Capacity Tray (RT3030)

Tray Capacity	1,500 sheets
Paper Size	8.5" x 11" (A4)
Paper Weight	16 - 80 lb. Bond/166 lb. Index (60 - 300 g/m ²)
Dimensions (WxDxH)	13.4" x 21.4" x 11.4" (340 x 545 x 290 mm)

Requires installation of Two-Tray Paper Bank (PB3220) or Tandem LCT (PB3230/PB3260)

Cabinet Type F

Dimensions (WxDxH)	23.1" x 26.7" x 10" (586 x 679 x 256 mm)
Weight	Less than 29.3 lbs. (13.25 kg)

Output Trays & Finisher Options

Internal Shift-Sort Tray (SH3070)

Tray Capacity	250 sheets (8.5" x 11" or smaller) (A4 - A5) 125 sheets (8.5" x 14" or larger) (B4 - A3)
Paper Size	5.5" x 8.5" to 12" x 18" (A5 - A3)
Paper Weight	14 - 80 lb. Bond/166 lb. Index (52 - 300 g/m ²)

Cannot be installed with any Finisher

1 Bin Tray (BN3110)

Paper Size	5.5" x 8.5" to 11" x 17" (A5 - A3)
Paper Weight	14 - 80 lb. Bond/166 lb. Index (52 - 300 g/m ²)

Tray Capacity

250-Sheet Stapleless Internal Finisher (SR3180)	Tray Capacity: 125 Sheets
Paper Size	5.5" x 8.5" to 11" x 17" (A6 - A3)
Paper Weight	14 - 80 lb. Bond/166 lb. Index (52 - 300 g/m ²)

Stack Capacity

250 sheets (8.5" x 11" or smaller) (A4)	125 sheets (8.5" x 14" or larger) (B4 - A3)
7.25" x 10.5" to 11" x 17" (A4 - A3)	17 - 21 lb. Bond (64 - 80 g/m ²)

Staple Paper Size

Staple Paper Weight	2 - 5 sheets/set
Staple Positions	Top, 1 Staple
Dimensions (WxDxH)	17.1" x 20.3" x 5.9" (435 x 515 x 150 mm)

500-Sheet Internal Finisher (SR3130)*

Paper Size	5.5" x 8.5" to 12" x 18" (A6 - A3)
Paper Weight	14 - 80 lb. Bond/166 lb. Index (52 - 300 g/m ²)

Stack Capacity

50 sheets (8.5" x 11" or smaller) (A4)	250 sheets (8.5" x 14" or larger) (B4 - A3)
8.5" x 11" to 11" x 17" (A4 - A3)	14 - 28 lb. Bond (52 - 105 g/m ²)

Staple Paper Size

Staple Paper Weight	50 sheets (8.5" x 11") (A4)
Staple Capacity	30 sheets (8.5" x 14" or larger, and/or Mixed Sizes) (B4 - A3)

Staple Positions

Dimensions (WxDxH)	Top, Bottom, 2 Staples 21.5" x 20.6" x 6.7" (546 x 523 x 170 mm)
--------------------	--

2-/3-Hole Punch Unit (PU3040NA)

(Optional; Installs inside SR3130 Internal Finisher)	Tray Capacity: 7.25" to 10.5" x 11" x 17" (A4 - A3)
Punch Paper Sizes	14 - 45 lb. Bond/93 lb. Index (52 - 169 g/m ²)

1,000-Sheet Hybrid Staple + Stapleless Finisher (SR3210)**

Paper Size	Proof Tray: 5.5" x 8.5" to 12" x 18" (A6 - A3) Shift Tray: 5.5" x 8.5" to 12" x 18" (A6 - A3) Proof Tray: 14 - 45 lb. Bond/93 lb. Index (52 - 169 g/m ²)
Paper Weight	Shift Tray: 14 - 80 lb. Bond/166 lb. Index (52 - 300 g/m ²)

Stack Capacity

Proof Tray: 250 sheets (8.5" x 11") (A4); 50 sheets (8.5" x 14" or larger) (A4 - B3)	Shift Tray: 1,000 sheets (8.5" x 11") (A4); 500 sheets (8.5" x 14" or larger) (A4 - B3)
---	--

Stapleless Capacity

Staple Capacity	2 - 5 sheets/set 50 sheets (8.5" x 11") (A4) 30 sheets (8.5" x 14" or larger) (B4)
-----------------	--

Staple Paper Size	8.5" x 11" to 11" x 17" (A4 - A3)
Staple Paper Weight	14 - 28 lb. Bond (52 - 105 g/m ²)
Staple Positions	Top, Bottom 2 Staples
Dimensions (WxDxH)	25.4" x 24.4" x 37.8" (646 x 620 x 960 mm)

1,000-Sheet Booklet Finisher (SR3220)**	Paper Size: Proof Tray: 5.5" x 8.5" to 12" x 18" (A6 - A3) Shift Tray: 5.5" x 8.5" to 12" x 18" (A6 - A3) Booklet Tray: 8.5" x 11" to 12" x 18" (A4 - A3)
--	---

Paper Weight	Proof Tray: 14 - 45 lb. Bond (52 - 169 g/m ²) Shift Tray: 14 - 80 lb. Bond/166 lb. Index (52 - 300 g/m ²) Booklet Tray: 14 - 28 lb. Bond (52 - 105 g/m ²)
--------------	---

Stack Capacity	Proof Tray: 250 sheets (8.5" x 11" or smaller) (A4); 50 sheets (8.5" x 14" or larger) (B4 - A3) Shift Tray: 1,000 sheets (8.5" x 11" or smaller) (A4); 500 sheets (8.5" x 14" or larger) (B4 - A3)
----------------	---

Staple Capacity	Booklet Tray: 20 Sets (2 - 5 sheets), 10 Sets (6 - 10 sheets) & 7 Sets (11 - 15 sheets)
-----------------	--

Saddle Stitch:	Normal Staple: 50 sheets (8.5" x 11") (A4); 30 sheets (8.5" x 14" or larger) (B4 - A3)
Saddle Paper Size	15 sheets Normal Staple: 8.5" x 11" to 12" x 18" (A4 - A3) Saddle Stitch: 8.5" x 11" to 12" x 18" (A4 - A3)

Staple Paper Weight	14 - 28 lb. Bond (52 - 105 g/m ²)
Staple Positions	Top, Bottom, 2 Staples, Booklet
Dimensions (WxDxH)	22.2" x 24.4" x 37.8" (563 x 620 x 960 mm)

2-/3-Hole Punch Unit (PU 3050NA)	(Optional; Installs inside SR3210 or SR3220 Finisher)
Punch Paper Sizes	5.5" x 8.5" to 11" x 17" (A5 - A3)
Punch Paper Weight	14 - 68 lb. Bond/142 lb. Index (52 - 256 g/m ²)

Additional Accessory Options

Bridge Unit BU3070, NFC Card Reader Type M29, HotSpot MFP Option Type S, ESP XG-PCS-15D Power Filter, Fax Connection Unit Type M29, G3 Interface Unit Type M29, Fax Memory Unit Type M19 64 MB, File Format Converter Type M19, IEEE 1284 Interface Board Type M19, IEEE 802.11a/b/g/n Interface Unit Type M19, Key Counter Bracket Type M3, OCR Unit Type M13, Optional Counter Interface Unit Type M12, PostScript3 Unit Type M29, Smart Card Reader Built-In Unit Type M29, SCR3310v2 USB Smart Card Reader, XPS Direct Print Option Type M29, Extended USB Board Type M19, External USB Keyboard (No Bracket), External Keyboard Bracket Type M19, Caster Table Type M3

* Caster Table Type M3 must be installed
** Requires configuration with Bridge Unit BU3070.
* Cannot be installed together.
* Requires installation of Two-Tray Paper Bank (PB3220) or Tandem Large Capacity Tray (PB3230/PB3260).
* Availability is limited, the PB3230 will be replaced by the PB3260 at a later date.
* Availability is limited, the PB3150 will be replaced by the PB3250 at a later date.

Note: Some accessories require additional equipment or may be prerequisites for other options. Some images contained in this brochure do not show the stabilizers that ship with the optional paper feed units. Some options may not be available at the time of market release.
Genuine Adobe® PostScript®3™ and PDF Direct from Adobe® are available as options. Specifications are subject to change without notice.
For maximum performance and yield, we recommend using genuine Savin parts and supplies.

www.savin.com

Ricoh USA, Inc., 70 Valley Stream Parkway, Mahwah, PA 18855, 1-877-472-8460
Savin® and the Savin logo are registered trademarks of Ricoh USA, Inc. Ricoh® and the Ricoh Logo are registered trademarks of Ricoh Company Ltd. All other trademarks are the property of their respective owners. ©2017 Ricoh USA, Inc. All rights reserved. Savin products and services are offered by Ricoh USA, Inc. and its affiliates. The content of this document, and the appearance, features and specifications of Savin products and services are subject to change from time to time without notice. Products are shown with optional features. While care has been taken to ensure the accuracy of this information, Ricoh makes no representation or warranties about the accuracy, completeness or adequacy of the information contained herein, and shall not be liable for any errors or omissions in these materials. Actual results will vary depending upon use of the products and services, and the conditions and factors affecting performance. The only warranties for Savin products and services are as set forth in the express warranty statements accompanying them.

SAVIN®

MP 4055
MP 5055
MP 6055

Multifunction B&W

- ✓ Copier
- ✓ Printer
- ✓ Facsimile
- ✓ Scanner

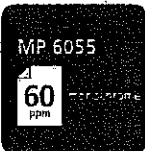
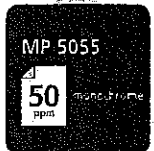
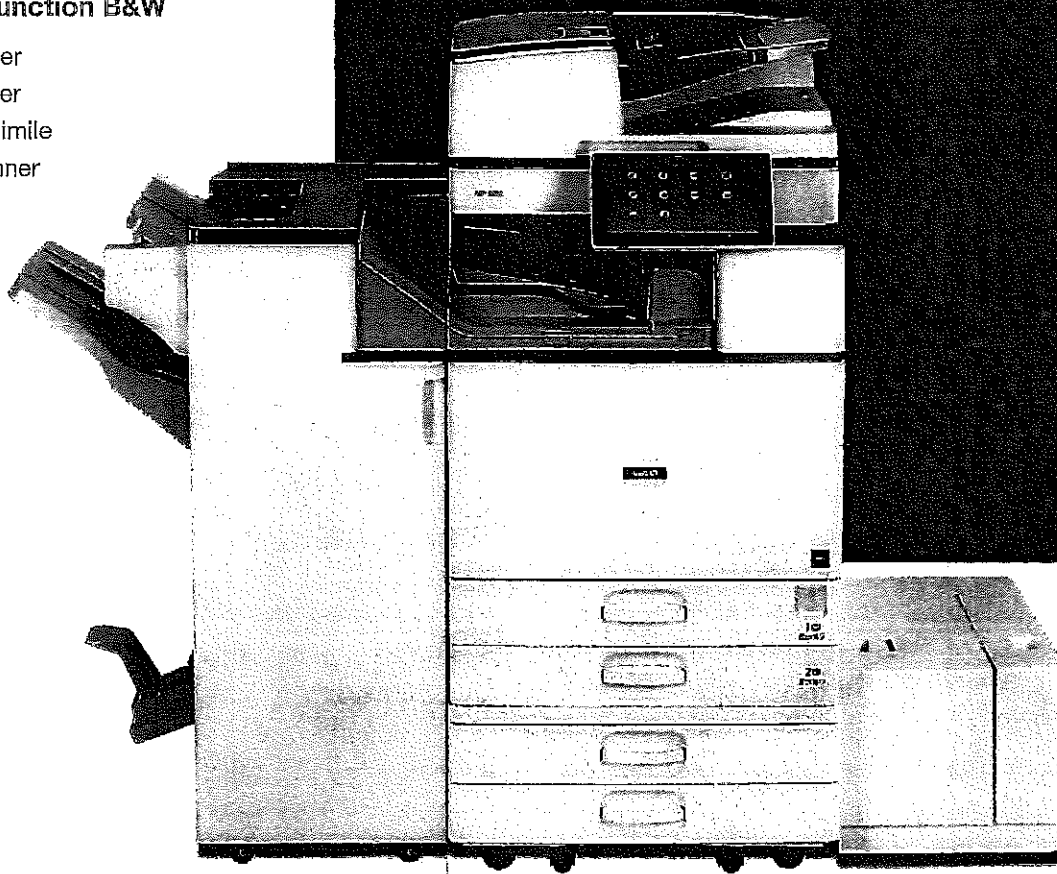

Put productivity on display

You face difficult choices every day. Fortunately, they're a lot easier to make when you have the right information. Choose the SAVIN® MP 4055/MP 5055/MP 6055 to print, copy, scan and fax important notes, brochures, invoices, contracts and other documents quickly and economically. With the advanced 10.1"-wide Super VGA Smart Operation Panel, you can pinch, swipe and scroll like you do on your smartphone or tablet to check and adjust settings, automate tasks and distribute information with speed and precision. Select from multiple finishing options to add a professional touch to documents while eliminating outsourced printing costs. Set shortcuts to expedite everyday jobs. Print and distribute files while on the move using your personal mobile device. Help keep your best ideas safe with user authentication and other security capabilities. Plus, the versatile all-in-one MFP is designed specifically to use less energy, which helps reduce costs.

- Print up to 60 black-and-white prints/copies per minute
- Use the Smart Operation Panel to copy, print, scan and fax quickly
- Create automated workflows and shortcuts to simplify everyday tasks
- Expedite sorting, stapling, folding and hole punching via a wide range of finishing options
- Share information from your smartphone or tablet using the MFP

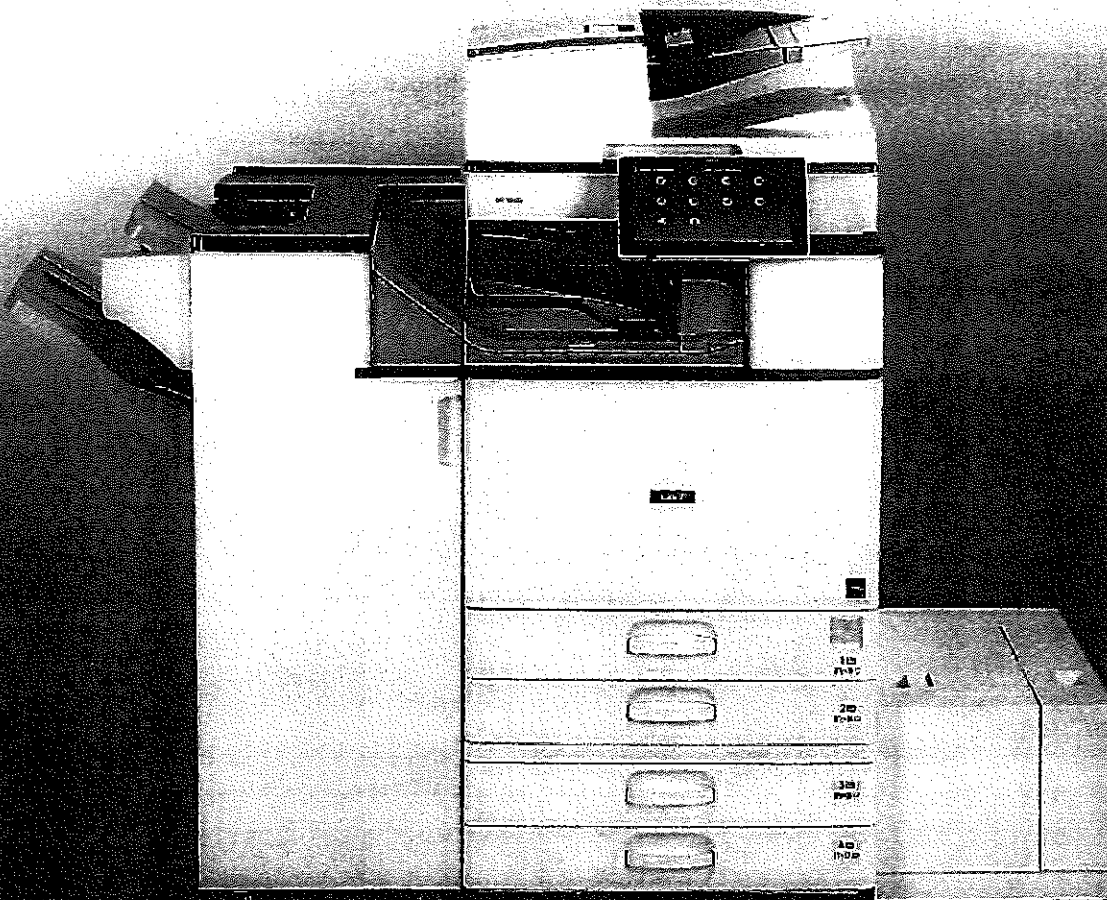

Create an easier way to work

Simplify tasks with customization and automation

Deliver on good information

Your best ideas can come at any time. Shouldn't you be able to share them the same way? Print up to 60 black-and-white pages per minute (ppm) to get the word out quickly. Use the standard Single Pass Document Feeder (SPDF) to transform one- or two-sided originals into digital files and distribute them via Scan-to options, including Scan-to-Email, FTP, PDF, URL and more. Store up to 3,000 frequently used forms on the embedded Document Server to keep the latest versions readily accessible. Add optional Optical Character Recognition (OCR) scanning to create searchable PDF files, so you can easily do a simple keyword search. An optional fax module lets you choose either Internet Faxing or LAN faxing over IP via optional Super G3 faxing to send digital files directly to your email inbox and reduce paper, transmission delays and multiple trips to the MFP.



Carry a lighter workload

When you stop, work stops. Use the MP 4055/MP 5055/MP 6055 to add workplace freedom without compromising productivity. Simply download the Smart Device Connector app on your Android® or iOS® devices to share information and print without printer setup configurations or utilities. Connect your Android and iOS devices with the MFP via Bluetooth (BLE), or Android devices using the Near Field Communication (NFC) tag. Grab information directly from cloud storage applications, such as Google Drive™, Box™ or Dropbox™ and print it using the Smart Device Connector app. Plus, you can now print emails and attachments with the latest version (v3.0) of the app. Scan originals at the MFP and send them to your personal device or directly to cloud storage, so you can access or distribute them digitally at your convenience. Printing from AirPrint® is also available.



Discover more ways to impress

Your audience knows a good idea when they see it. Use the MP 4055/MP 5055/MP 6055 to ensure they get a clearer look. Whether you're in a PC, Mac or Linux, you can produce crisp images with smooth gradations and precise text at up to 1200 dpi resolution. Print brochures, direct mail, presentations and more on a wide range of media — including envelopes, 11" x 17" sizes and thicker stocks up to 300 g/m² — to keep any audience's attention. You can even create an easy-to-see poster from one of your current documents. Choose between the icon-driven drivers to easily make subtle image changes prior to printing. For customers that require more complex work flows, these new devices now include standard PostScript to help improve productivity. With the 1.46 GHz Intel® controller, you can perform any task quickly and handle multiple jobs simultaneously. Plus, you can add optional paper trays to expand paper capacity to 4,700 sheets and output job after job on various paper types and sizes.

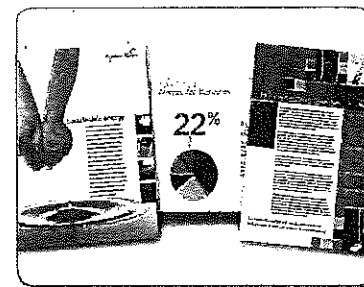

Press ahead with customized convenience

Tap into critical information

Use the large intuitive Smart Operation Panel to find important information and toggle between jobs and tasks quickly and conveniently with a single pinch, swipe or scroll. Designed with Workstyle Innovation Technology, the touchscreen offers multiple all-digital user interfaces that display critical information in a grid-like layout via easily identifiable icons. You can customize the look and layout and choose what's on display. Simply tap on any icon to access data, change settings, perform tasks and more. You can also find information online with the embedded web browser. Print web pages, images and documents as PDFs at any time.

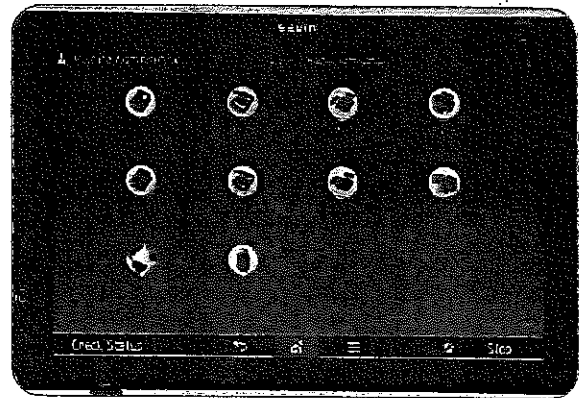

Create shortcuts to productivity

You know what you have to do. Now, you know how to do it faster. Customize your own automated workflows on the Smart Operation Panel and reduce repetitive manual steps that can impede the flow of information. Download easy-to-use workflow apps from our Application Site to add specific features or single-function capabilities to simplify how you perform everyday tasks. For example, you can download the Conference Concierge app for step-by-step instructions on how to create supporting materials in the right format for your next big event. Download the ID Card Scan & Copy app to scan two-sided originals onto one side of a sheet of paper. You can even download the How-to Videos app for quick, convenient tutorials to expedite troubleshooting and customization tasks.



Add software solutions to reduce your workload

There's always a way to get things done. More importantly, with the MP 4055/MP 5055/MP 6055, there's always an easier way. Add solutions to simplify complex workflows and automate many of your repetitive everyday tasks. With GlobalScan™ NX, you can digitize hardcopy originals and distribute them anywhere almost instantly with minimal effort. Use Streamline NX® for document creation, storage, retrieval, distribution, card authentication and more. Add Device Manager NX Accounting and issue chargebacks for individuals and workgroups with incredible speed and accuracy.



Perform every task with everyday consistency

Be secure with your message

Reduce risks with a wide range of security controls. Track users and their activity with User Authentication. Have every person enter a passcode or swipe an ID card by the optional NFC or HID card readers to access the device. Set print quotas for individuals or workgroups to minimize unnecessary printing. With Locked Print, jobs are held until the authorized user releases them, so sensitive information isn't left unattended for passersby. The hard disk drive includes powerful encryption protection, so you can share files with confidence, and a DataOverwriteSecurity System (DOSS) overwrites latent images on the hard drive.

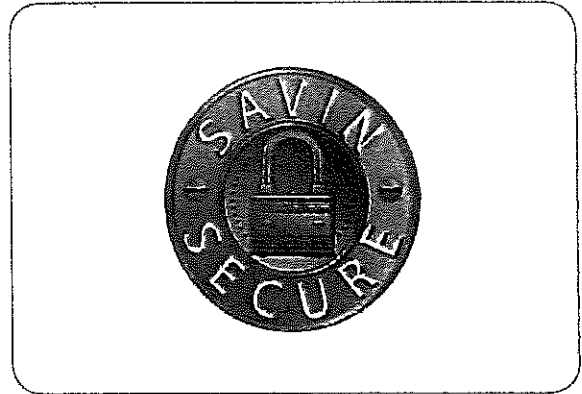

Help reduce environmental impact

The MP 4055/MP 5055/MP 6055 is easy on your workload — and your budget. Take advantage of its many eco-friendly features. The MFP is ENERGY STAR® certified and meets EPEAT® Gold criteria*. We left some of the energy-saving options up to you. For example, you can schedule the MFP to power down when the office is empty and keep duplex printing as the default to reduce paper costs.

*EPEAT Gold rating is applicable only in the USA.

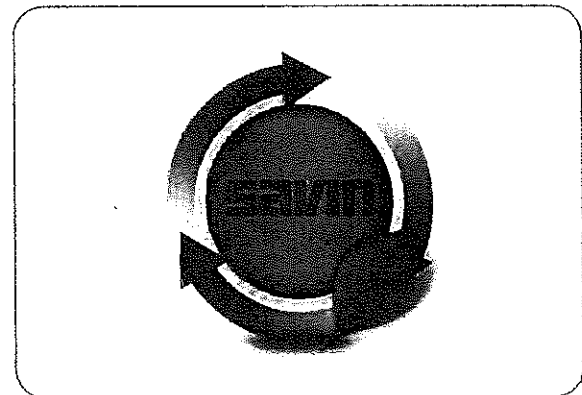

Perform administrative tasks with ease

Improve productivity throughout your fleet with multiple remote administrative tools. Add Device Manager NX to configure devices, add updates, monitor usage and more from a web browser. Install print drivers remotely with Device Software Manager. For meter reads and performance reports, use @Remote to collect data automatically. You'll know immediately when service is required via automated service alerts sent directly to your email inbox. Plus, our trained technicians are ready to help at any time.

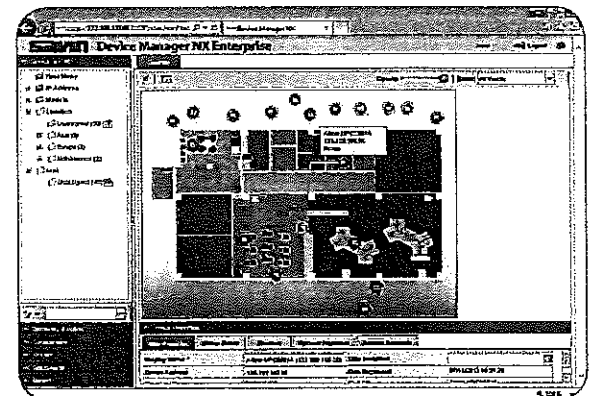

To view detailed features of our multifunction products online go to www.savin.com/products

Bring many enhancements to any environment

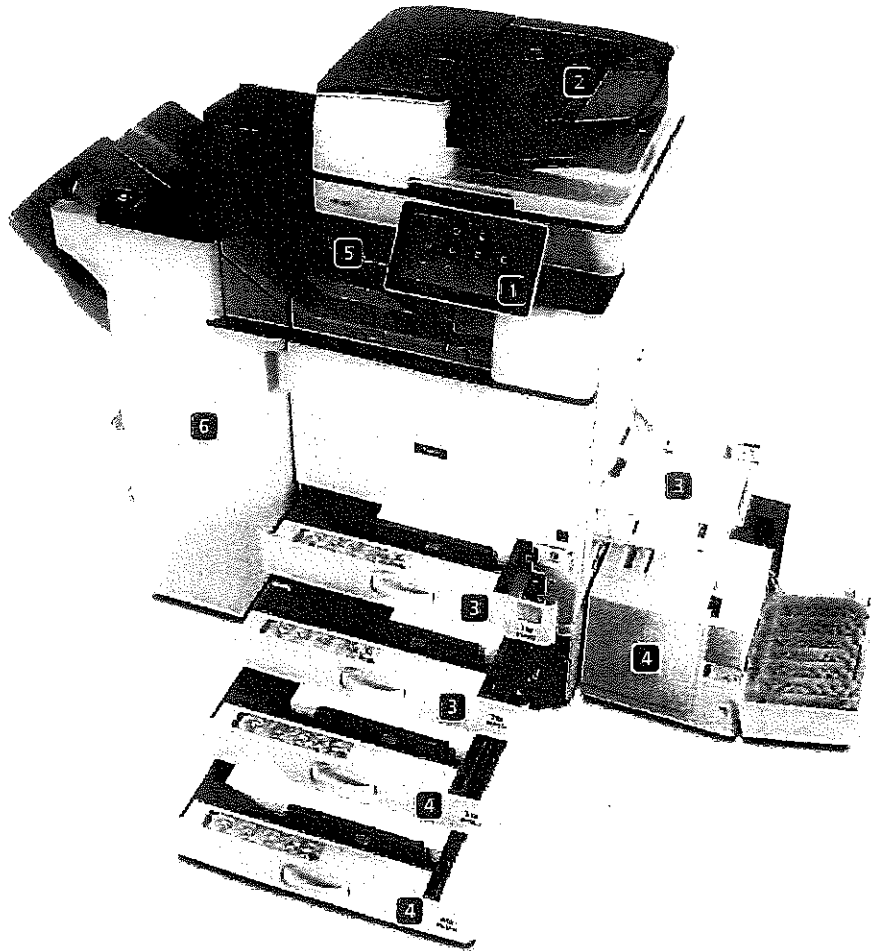

- 1 Full-Color 10.1"-Wide Super VGA Smart Operation Panel:** With the same pinch-and-flick and swipe scrolling gestures you use on your smartphone and tablet, you can access information, check settings and perform tasks quickly and effortlessly.
- 2 Single Pass Document Feeder:** Load up to 220 single-sided or double-sided color or black-and-white originals in the Single Pass Document Feeder (SPDF) for fast and easy scanning, copying and faxing.
- 3 Standard Paper Trays:** Take advantage of two 550-Sheet Paper Trays and the 100-Sheet Bypass Tray to store up to 1,200 sheets of paper, including 11" x 17" stocks.
- 4 Additional Paper Storage (Optional):** Expand capacity up to 4,700 sheets with a 2,000-Sheet Tandem Large Capacity Tray and 1,500-Sheet Side Large Capacity Tray. You can also choose a 1 x 550-Sheet Paper Tray or 2 x 550-Sheet Paper Tray to encourage on-demand printing.
- 5 Document Retrieval:** Retrieve output easily — even in larger offices with multiple users — via the optional 125-Sheet 1-Bin Tray and the 250-Sheet Internal Shift-Sort Tray.
- 6 Document Finishing:** Create your own production solution by choosing from multiple optional finishers. Choose a 500-Sheet Stapler Finisher to save floor space or opt for the external 3,000-Sheet Stapler Finisher to add a professional touch to larger jobs. Take your pick between 1,000-Sheet and 2,000-Sheet Booklet Finishers. Plus, you can opt for the 1,000-Sheet Hybrid Staple + Stapleless Finisher. Use it to toggle between stapled or stapleless finishing automatically depending on the number of pages you print. Stapleless finishing is ideal for schools, hospitals and public offices where recycling and safety are especially important.
- Document Folding (not shown):** Use the optional Internal Multi-Fold Unit to automate different types of paper folds, including tri-, Z- and half-folding, and produce more types of professional output in-house.

Be professional to the finish

Choose from a wide range of optional, easy-to-use finishers to enhance presentations, handouts, manuals and more to engage customers and coworkers. Each finisher helps automate tedious manual and repetitive tasks so you can move on to the next idea and the next opportunity quickly.

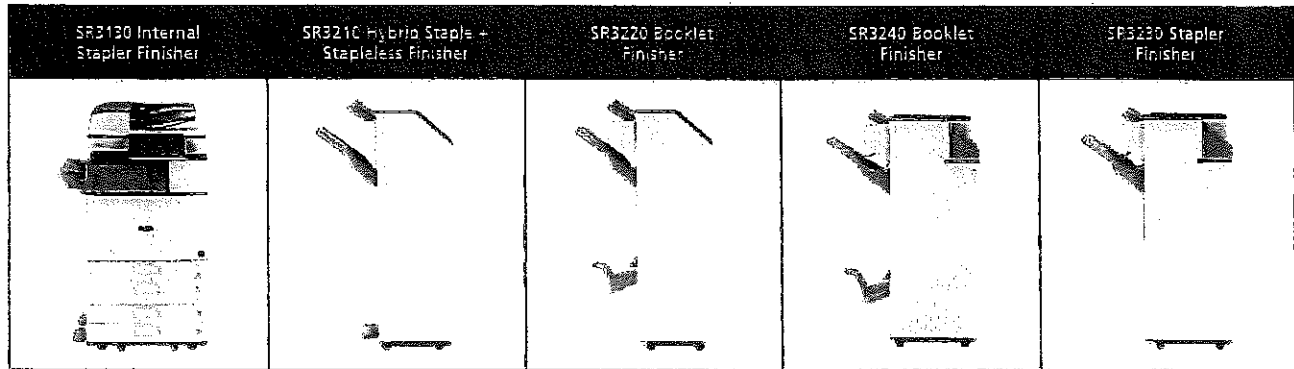

Finisher	Paper	Hole-Punch	Saddle-Stitch	Stapleless	Supported Systems
SR3130 Internal Stapler Finisher	500 Sheets	Optional	N/A	N/A	MP 4055/MP 5055
SR3210 Hybrid Staple + Stapleless Finisher	1,000 Sheets	Optional	N/A	2 - 5 Sheets/Set	All
SR3220 Booklet Finisher	1,000 Sheets	Optional	Up to 15 Sheets	N/A	All
SR3240 Booklet Finisher	2,000 Sheets	Optional	Up to 20 Sheets	N/A	All
SR3230 Stapler Finisher	3,000 Sheets	Optional	N/A	N/A	All

Engine/Copier Specifications

Configuration	Desktop
Scanning Element	One-Dimensional Solid Scanning Through CCD
Printing Process	Twin Laser Beam Scanning & Electrophotographic Printing
Toner Type	Dry, dual component
Copy Resolution	600 x 600 dpi
Maximum Copy Quantity	Up to 999
First Page Out Time	4.0 seconds for MP 4055 2.9 seconds for MP 5055/MP 6055
Warm-Up Time	Less than 24 seconds
Recovery From Sleep Mode	MP 4055: 7.9 seconds MP 5055: 8.2 seconds MP 6055: 8.7 seconds
Memory (Standard/Maximum)	2 GB RAM + 320 GB HDD (Shared)
Original Type	Book/Sheet/Object
Maximum Original Size	Up to 11" x 17"
B&W Print Speed (Letter/A4)	MP 4055: 40 prints/minute MP 5055: 50 prints/minute MP 6055: 60 prints/minute
Power Source	120V/60Hz/12A
Max. Power Consumption	Less than 1.6kW
Typical Electricity Consumption (TEC)**	MP 4055: 1.6 kWh/week MP 5055: 2.1 kWh/week MP 6055: 2.6 kWh/week
Standard Paper Capacity	1,200 sheets (550 sheets x 2 trays and 100-Sheet Bypass Tray)
Maximum Paper Capacity	4,700 sheets (w/ tandem LCT + Side LCT)
Supported Paper Types	Plain, Recycled, Colored, Special, Letterhead, Preprinted, Pre-punched, Bond, Cardstock, Envelope, OHP*, Label*
Supported Paper Sizes	Tray 1 & 2: 5.5" x 8.5" - 11" x 17" (A6 - A3) Bypass Tray: 5.5" x 8.5" - 12" x 18" (A6 - A3)
Supported Paper Weights	Tray 1 & 2: 16 - 80 lb. Bond (60 - 300 g/m ²) Bypass: 14 - 80 lb. Bond (52 - 300 g/m ²) Duplex: 14 - 68 lb. Bond (52 - 256 g/m ²) 500 sheets
Standard Output Capacity	
Maximum Output Capacity	3,625 sheets (Bridge Unit + 1 Bin + 3,000-Sheet Finisher)
Document Feeder Type	Standard Single Pass Document Feeder (SPDF)
Document Feeder Original Size	5.5" x 8.5" - 11" x 17" (A5 - A3)
Document Feeder Paper Weight	Simplex 11 - 34 lb. Bond (40 - 128 g/m ²) Duplex: 14 - 34 lb. Bond (52 - 128 g/m ²)
Document Feeder Capacity	220 sheets
Preset Reduction & Enlargement Ratios	25%, 50%, 65%, 73%, 78%, 85%, 93%, 100%, 121%, 129%, 155%, 200%, 400%

Zoom Range Standard Features

Zoom Range	25% to 400% in 1% increments
Standard Features	Auto Paper Select, Auto Tray Switch, Auto Image Density, Auto Text & Photo Separation, Auto Start, Auto Off Timer, Booklet/Magazine Copy, Shift/Erase/Margin Adjustment, Combine (Layout), Cover/Chapter/Slip Sheets Insertion, Image Rotation, Document Server (3,000 File Capacity) with Folder Management and Password Protection, Web Browser, Duplex, Electronic/Rotate Sorting, 8 Job Presets, 25 Job Programs, Negative/Positive, Sample Copy, Series Copy, Simplified Display, 1,000 User Codes, Stamps/Numbering, Interrupt Copy, Login/Logout Button, System Reset Timer, Import/Export of Preference Settings, Eco-Friendly Indicator, Centralized Address Book Management
Dimensions (WxDxH) (includes standard SPDF)	23.1" x 26.9" x 37.9" (587 x 684 x 963 mm)
Weight	168.6 lbs. (76.5) kg
*Bypass Tray only	
**Typical electricity consumption by ENERGY STAR program	

Printer Specifications (Standard)

Processor Speed	Intel® Atom Processor BayTrail-H 1.46 GHz
Connection Type	Standard on Device: 10Base-T/100Base-TX/1000Base-T Ethernet, USB Host Type A VF (2 ports on back of device) Standard on Operation Panel: USB Host (Type A: 1Port/Support USB Flash Memory), USB Host (Type A: 1Port/Support optional Keyboard etc), USB Host Type Mini B and SD Card Slot Optional: IEEE 1284/ECP, IEEE 802.11b/g/n Wireless LAN TCP/IP (IPv4, IPv6) Windows Vista®/7®/8.1/10, Server 2008/2008R2/2012/2012R2; Unix Filters for Sun Solaris 9/10, HP-UX 11.11/11 v2/11 v3, SCO OpenServer 5.0.7/6.0, Red Hat Linux Enterprise V4/V5/V6, IBM AIX 5L/V5.3/V6.1/V7.1, Mac OS X 10.7 or later, SAP R/3, IBM iSeries AS/400* using OS/400 Host Print Transform, Citrix Xen App 6.5 or later
Network Protocols Supported Operating Systems	Web Image Monitor, Embedded @Remote, @Remote Office Appliance, @Remote Connector NX, @Remote Enterprise Pro, Device Manager NX Lite and Accounting, Device Manager NX Pro and Enterprise, Printer Driver Packager NX
Device Management Utilities	

Printer Languages

Printer Languages	Standard: PostScript emulation, PCL5e/PCL6 Optional: Adobe® PostScript®3™, XPS
Print Resolution Standard Features	Up to 1200 x 1200 dpi Sample/Locked/Hold/Scheduled/Stored/Store and Print, PDF Direct Print, Mail to Print, Classification Code, Bonjour Support, Windows Active Directory Support, DDNS Support, PCL Resident Font Adoption, Tray Parameter Change from Web Image Monitor, 1200 dpi Support, Universal Driver, XPS Support, WS Printer, Media Direct Print (Print from USB/SD), Banner Page Print, Auto Job Promotion, Poster Print, WPS Support, Send to Document Server, Layout (N-up), Watermark, Slip Sheet, Rotate, Do Not Print Blank Pages, Dithering, Toner Saving, Black Over Print, User ID/Code/Authentication, Edge to Edge Print

Scanner Specifications (Standard)

Scan Speed (B&W & Full Color)	Simplex - 110 ipm/Duplex - 180 ipm (A4)
Scan Resolution	Full Color & B&W: Up to 600 dpi TWAIN: Up to 1200 dpi
Scan Area/Platen Size	Up to 11" x 17"
Connection Type	Standard: 10Base-T/100Base-TX/1000Base-T Ethernet Optional: IEEE 802.11a/b/g/n Wireless LAN TCP/IP, SMB, SMTP, POP, LDAP, FTP, IMAP4 Single and Multi-Page TIFF/PDF, High Compression PDF, PDF/A and Single-Page JPEG
Protocol File Formats	Embedded Scan-to Email/Folder/SMB/FTP/JRNL/PDF/A/Digitally Signed PDF, TWAIN and Color Scanning, Auto Size Detection, Auto Density Selection, Image Rotation, SADF/Batch Mode, Mixed Size Mode, Reduce and Enlarge, Split Scan from Booklet Type Original, WS Scanner, LDAP Support, Preview Before Transmission, PDF Encryption, Drop Out Color Send, Distributed Scan Management
Standard Features	

Savin MP 4055/MP 5055/MP 6055



Fax Specifications (Option)

Fax Option Type M29

Circuit PSTN, PBX
 Compatibility ITU-T (CCITT) G3
 Resolution 200 x 200/100 dpi; 400 x 400 dpi (optional)
 Compression Method MH, MR, MMR, JBIG
 Scanning Speed (LET) Up to 68 spm (Letter/A4)
 Modem Speed G3: 3 seconds per page (MMR Compression)
 Transmission Speed G3: 2 seconds per page (JBIG Compression)
 SAF Memory 4 MB standard/64 MB maximum
 (320 pages/4,800 pages)

Max Auto Dials

Group Dials 2,000

Standard Features

One Hour Backup, LAN-Fax Capability, Internet Faxing (I37), IP Faxing (I38), Fax Forwarding to E-Mail/Folder, Paperless Fax (HDD), Detection of Misplaced Document, Double-check of Destination Address, Direct SMTP, LDAP Support, Universal Send (Simultaneous Fax and Scan), Fax Line Assignment, Fax Output Timer

Optional Features

Remote Fax, Simultaneous Operation of up to 3 lines (G3 x 3)

Security Features (Standard)

DataOverwriteSecurity System (DOSS), Windows/LDAP/Basic/User Code/802.1x Wired Authentication, Address Book/Authentication Password/SSL Communication/SMTPsec Communication/HDD/SMTP over SSL/TLS/Wireless LAN Encryption, Network Protocol On/Off, IP Filtering, Unauthorized Copy/Print Prevention, Quota Setting/Account Limit, Compulsory Security Stamp, HDD Encryption

Optional Hardware Accessories

Paper Handling & Cabinet Options

One-Tray Paper Bank (PB3150/PB3250)**

Tray Capacity 550 sheets x 1 tray
 Paper Size 5.5" x 8.5" to 11" x 17" (A5 - A3)
 Paper Weight 16 - 80 lb. Bond/166 lb. Index (60 - 300 g/m²)
 Dimensions (WxDxH) 23.1" x 27" x 4.7" (587 x 685 x 120 mm)
 Requires installation of Caster Table Type M3

Two-Tray Paper Bank (PB3220)**

Tray Capacity 1,100 sheets (550 sheets x 2 trays)
 Paper Size 5.5" x 8.5" to 11" x 17" (A5 - A3)
 Paper Weight 16 - 80 lb. Bond/166 lb. Index (60 - 300 g/m²)
 Dimensions (WxDxH) 23.1" x 27" x 9.7" (587 x 685 x 247 mm)

Tandem Large Capacity Tray (PB3230/PB3260)*

Tray Capacity 2,000 sheets (1,000 sheets x 2)
 Paper Size 8.5" x 11" (A4)
 Paper Weight 14 - 80 lb. Bond/166 lb. Index (60 - 300 g/m²)
 Dimensions (WxDxH) 23.1" x 27" x 9.7" (587 x 685 x 247 mm)

Side Large Capacity Tray (RT3030)

Tray Capacity 1,500 sheets
 Paper Size 8.5" x 11" (A4)
 Paper Weight 16 - 80 lb. Bond/166 lb. Index (60 - 300 g/m²)
 Dimensions (WxDxH) 13.4" x 21.4" x 11.4" (340 x 545 x 290 mm)
 Requires installation of Two-Tray Paper Bank (PB3220) or Tandem LCT (PB3230/PB3260)

Cabinet Type F

Dimensions (WxDxH) 23.1" x 26.7" x 10" (586 x 679 x 256 mm)
 Weight less than 29.3 lbs. (13.25 kg)

Output Trays & Finisher Options

Internal Shift-Sort Tray (SH3070)*

Tray Capacity 250 sheets (8.5" x 11" or smaller) (A4 - A5)
 125 sheets (8.5" x 14" or larger) (B4 - A3)
 Paper Size 5.5" x 8.5" to 12" x 18" (A5 - A3)
 Paper Weight 14 - 80 lb. Bond/166 lb. Index (52 - 300 g/m²)
 Cannot be installed with any Finisher

1 Bin Tray (BN3110)

Paper Size 5.5" x 8.5" to 11" x 17" (A5 - A3)
 Paper Weight 14 - 80 lb. Bond/166 lb. Index (52 - 300 g/m²)
 Tray Capacity 125 Sheets
 Internal Multi-Fold Unit (FD3000)

Folding Type Z-Fold, Half-Fold, Outer Tri-Fold, Inner Tri-Fold
 Paper Size Z-Fold, Half-Fold: A3, B4, A4, DII, LG, LT, 8k, 8.5" x 13.4" (Oficio)
 Outer or Inner Tri-Fold: A3, A4, DII, LG, LT, 8.5" x 13.4" (Oficio)

Paper Size Z-Fold: A3, B4, A4, DII, LG, LT, 8k, 8.5" x 13.4" (Oficio)
 Half-Fold: A3, B4, A4, DII, LG, LT, 8k, 8.5" x 13.4" (Oficio), 12" x 18", 12.6" x 17.7" (SRA3)
 Outer or Inner Tri-Fold: A3, A4, DII, LG, LT, 8.5" x 13.4" (Oficio)
 Dimensions (WxDxH) 24.09" x 21.85" x 7.24" (612 x 555 x 184 mm)
 Weight 33 lb. (15 kg)

500-Sheet Internal Stapler Finisher (SR3130)**
 Paper Size 5.5" x 8.5" to 12" x 18" (A6 - A3)
 Paper Weight 14 - 80 lb. Bond/166 lb. Index (52 - 300 g/m²)
 Stack Capacity 500 sheets (8.5" x 11" or smaller) (A4 - A3)
 250 sheets (8.5" x 14" or larger) (B4 - A3)
 Staple Paper Size 7.25" x 10.5" to 11" x 17" (A4 - A3)
 Staple Paper Weight 14 - 28 lb. Bond (52 - 105 g/m²)
 Staple Capacity 50 sheets (8.5" x 11") (A4)
 30 sheets (8.5" x 14" or larger, and/or Mixed Sizes) (B4 - A3)

Staple Positions Top, Bottom, 2 Staples
 Dimensions (WxDxH) 21.5" x 20.6" x 6.7" (546 x 523 x 170 mm)
 2-/3-Hole Punch Unit (PU3040NA)
 (Optional; Installs inside SR3130 Internal Finisher)
 Punch Paper Sizes 7.25" x 10.5" to 11" x 17" (A4 - A3)
 Punch Paper Weight 14 - 45 lb. Bond/93 lb. Index (52 - 169 g/m²)

1,000-Sheet Hybrid Staple + Stapleless Finisher (SR3210)**
 Paper Size Proof Tray: 5.5" x 8.5" to 12" x 18" (A6 - A3)
 Shift Tray: 5.5" x 8.5" to 12" x 18" (A6 - A3)
 Paper Weight Proof Tray: 14 - 45 lb. Bond/93 lb. Index (52 - 169 g/m²)
 Shift Tray: 14 - 80 lb. Bond/166 lb. Index (52 - 300 g/m²)

Stack Capacity Proof Tray: 250 sheets (8.5" x 11") (A4); 50 sheets (8.5" x 14" or larger) (A4 - B3)
 Shift Tray: 1,000 sheets (8.5" x 11") (A4); 500 sheets (8.5" x 14" or larger) (A4 - B3)
 Stapleless Capacity 2 - 5 sheets/set
 Staple Capacity 50 sheets (8.5" x 11") (A4)
 30 sheets (8.5" x 14" or larger) (B4)

Staple Paper Size 8.5" x 11" to 11" x 17" (A4 - A3)
 Staple Paper Weight 14 - 28 lb. Bond (52 - 105 g/m²)
 Staple Positions Top, Bottom 2 Staples
 Dimensions (WxDxH) 22.2" x 24.4" x 37.8" (563 x 620 x 960 mm)

1,000-Sheet Booklet Finisher (SR3220)**
 Paper Size Proof Tray: 5.5" x 8.5" to 12" x 18" (A6 - A3)
 Shift Tray: 5.5" x 8.5" to 12" x 18" (A6 - A3)
 Booklet Tray: 8.5" x 11" to 12" x 18" (A4 - A3)
 Paper Weight Proof Tray: 14 - 45 lb. Bond (52 - 169 g/m²)
 Shift Tray: 14 - 80 lb. Bond/166 lb. Index (52 - 300 g/m²)
 Booklet Tray: 14 - 28 lb. Bond (52 - 105 g/m²)

Stack Capacity Proof Tray: 250 sheets (8.5" x 11" or smaller) (A4); 50 sheets (8.5" x 14" or larger) (B4 - A3)
 Shift Tray: 1,000 sheets (8.5" x 11") (A4); 500 sheets (8.5" x 14" or larger) (B4 - A3)
 Booklet Tray: 20 Sets (2 - 5 sheets), 10 Sets (6 - 10 sheets) & 7 Sets (11 - 15 sheets)
 Normal Staple: 50 sheets (8.5" x 11") (A4); 30 sheets (8.5" x 14" or larger) (B4 - A3)
 Saddle Stitch: 15 sheets
 Paper Weight 14 - 28 lb. Bond (52 - 105 g/m²)
 Dimensions (WxDxH) 22.2" x 24.4" x 37.8" (563 x 620 x 960 mm)

2-/3-Hole Punch Unit (PU 3050NA)
 (Optional; Installs inside SR3210 or SR3220 Finisher)
 Punch Paper Sizes 5.5" x 8.5" to 11" x 17" (A5 - A3)
 Punch Paper Weight 14 - 68 lb. Bond/142 lb. Index (52 - 256 g/m²)

2,000-Sheet Booklet Finisher (SR3240)**
 Paper Size Proof Tray: 5.5" x 8.5" to 12" x 18" (A6 - A3)
 Shift Tray: 5.5" x 8.5" to 12" x 18" (A6 - A3)
 Booklet Tray: 8.5" x 11" to 12" x 18" (A4 - A3)
 Paper Weight Proof Tray: 14 - 58 lb. Bond/122 lb. Index (52 - 220 g/m²)
 Shift Tray: 14 - 80 lb. Bond/166 lb. Index (52 - 300 g/m²)
 Booklet Tray: 17 - 28 lb. Bond (64 - 105 g/m²)

Stack Capacity Proof Tray: 250 sheets (8.5" x 11" or smaller) (A4); 50 sheets (8.5" x 14" or larger) (B4)
 Shift Tray: 2,000 sheets (8.5" x 11" or smaller) (A4); 1,000 sheets (8.5" x 14" or larger) (B4)
 Booklet Tray: 30 sets (2 - 5 sheets) or 15 sets (6 - 10 sheets) or 6 sets (11 - 15 sheets) or 6 sets (16 - 20 sheets)
 Normal Staple: 50 sheets (8.5" x 11" to 11" x 17" and Mixed Sizes) (A4 - A3)
 Saddle Stitch: 20 sheets

Staple Paper Size Normal Staple: 8.5" x 11" to 11" x 17" (A4 - A3)
 Saddle Stitch: 8.5" x 11" to 12" x 18" (A4 - A3)
 Staple Paper Weight 14 - 28 lb. Bond (52 - 105 g/m²)
 Staple Positions Top, Bottom, 2 Staples, Top Slant, Booklet
 Dimensions (WxDxH) 25.9" x 24.1" x 37.8" (657 x 613 x 960 mm)

3,000-Sheet Stapler Finisher (SR3230)**
 Paper Size Proof Tray: 5.5" x 8.5" to 12" x 18" (A6 - A3)
 Shift Tray: 5.5" x 8.5" to 12" x 18" (A6 - A3)
 Paper Weight Proof Tray: 14 - 58 lb. Bond/122 lb. Index (52 - 220 g/m²)
 Shift Tray: 14 - 80 lb. Bond/166 lb. Index (52 - 300 g/m²)

Stack Capacity Proof Tray: 250 sheets (8.5" x 11" or smaller) (A4); 50 sheets (8.5" x 14" or larger) (B4)
 Shift Tray: 3,000 sheets (8.5" x 11") (A4); 1,500 sheets (8.5" x 14" or larger) (B4)
 50 sheets (8.5" x 11" to 11" x 17") or Mixed Sizes (A4 - A3)
 Staple Paper Size 8.5" x 11" to 11" x 17" (A4 - A3)
 Staple Paper Weight 14 - 28 lb. Bond (52 - 105 g/m²)
 Staple Positions Top, Bottom, 2 Staples, Top Slant
 Dimensions (WxDxH) 25.9" x 24.1" x 37.8" (657 x 613 x 960 mm)

2-/3-Hole Punch Unit (PU3060NA)
 (Optional; Installs inside SR3230 or SR3240 Finishers)
 Punch Paper Sizes 5.5" x 8.5" to 11" x 17" (A5 - A3)
 Punch Paper Weight 14 - 68 lb. Bond/142 lb. Index (52 - 256 g/m²)

Additional Accessory Options
 Bridge Unit BU3070, NFC Card Reader Type M29, HotSpot MFP Option Type S, ESP XG-PCS-15D Power Filter, Fax Connection Unit Type M29, G3 Interface Unit Type M29, Fax Memory Unit Type M19 64 MB, File Format Converter Type M19, IEEE 1284 Interface Board Type M19, IEEE 802.11a/b/g/n Interface Unit Type M19, Key Counter Bracket Type M3, OCR Unit Type M13, Optional Counter Interface Unit Type M12, PostScript3 Unit Type M29, Smart Card Reader Built-in Unit Type M29, SCR3310v2 USB Smart Card Reader, XPS Direct Print Option Type M29, Extended USB Board Type M19, External USB Keyboard (No Bracket), External Keyboard Bracket Type M3, Caster Table Type M3

*Caster Table Type M3 must be installed
 *Requires configuration with Bridge Unit BU3070.
 *Cannot be installed together.
 *Requires installation of Two-Tray Paper Bank (PB3220) or Tandem Large Capacity Tray (PB3230/PB3260).
 *Not available for MP 6055.

*Availability is limited, the PB3150 will be replaced by the PB3250 at a later date.
 *Availability is limited, the PB3230 will be replaced by the PB3260 at a later date.

Note: Some accessories require additional equipment or may be prerequisites for other options. Some images contained in this brochure do not show the stabilizers that ship with the optional paper feed units. Some options may not be available at the time of market release.

Genuine Adobe® PostScript®3 and PDF Direct from Adobe® are available as options. Specifications are subject to change without notice.

For maximum performance and yield, we recommend using genuine Savin parts and supplies.

www.savin.com

Ricoh USA, Inc., 70 Valley Stream Parkway, Mahwah, PA 19355, 1-877-473-8469
 Savin® and the Savin logo are registered trademarks of Ricoh USA, Inc. Ricoh® and the Ricoh Logo are registered trademarks of Ricoh Company Ltd. All other trademarks are the property of their respective owners. ©2017 Ricoh USA, Inc. All rights reserved. Savin products and services are offered by Ricoh USA, Inc. and its affiliates. The content of this document, and the appearance, features and specifications of Savin products and services are subject to change from time to time without notice. Products are shown with optional features. While care has been taken to ensure the accuracy of this information, Ricoh makes no representation or warranty about the accuracy, completeness or adequacy of the information contained herein, and shall not be liable for any errors or omissions in these materials. Actual results will vary depending upon use of the products and services, and the conditions and factors affecting performance. The only warranties for Savin products and services are as set forth in the express warranty statements accompanying them.

S3831-C

SAVIN®

MP 6503
MP 7503
MP 9003

Multifunction B&W

- ✓ Copier
- ✓ Printer
- ✓ Facsimile
- ✓ Scanner

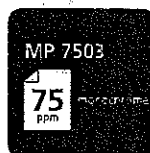

Use what you know to work the way you want

You have the know-how, but how can you use it to be more productive in higher volume work environments? With the SAVIN® MP 6503/MP 7503/MP 9003, you can take advantage of our new Workstyle Innovation Technology and simplify the way you work. Use what you know about specific tasks, jobs, users and more to customize automated workflows. Add one-touch shortcuts to transform your best ideas into actionable information and share it with anybody in any location via a wide range of scan-to capabilities. Download informative widgets and make more informed decisions that improve the speed and quality of your work. Find new ways to remain productive even when you're out of the office. Print directly from your smartphone or tablet and manage system administrative controls via your desktop. Do it all knowing critical information is protected with leading security features, including user authentication and encryption.

- Produce up to 90 black-and-white prints/copies per minute
- Simplify complex tasks with versatile multifunction performance
- Customize workflows with an intuitive touchscreen to improve productivity
- Boost collaboration with an embedded web browser and "Cloud-solution-ready" capabilities
- Streamline administration with easy-to-use remote management tools
- Protect documents and data from unauthorized users

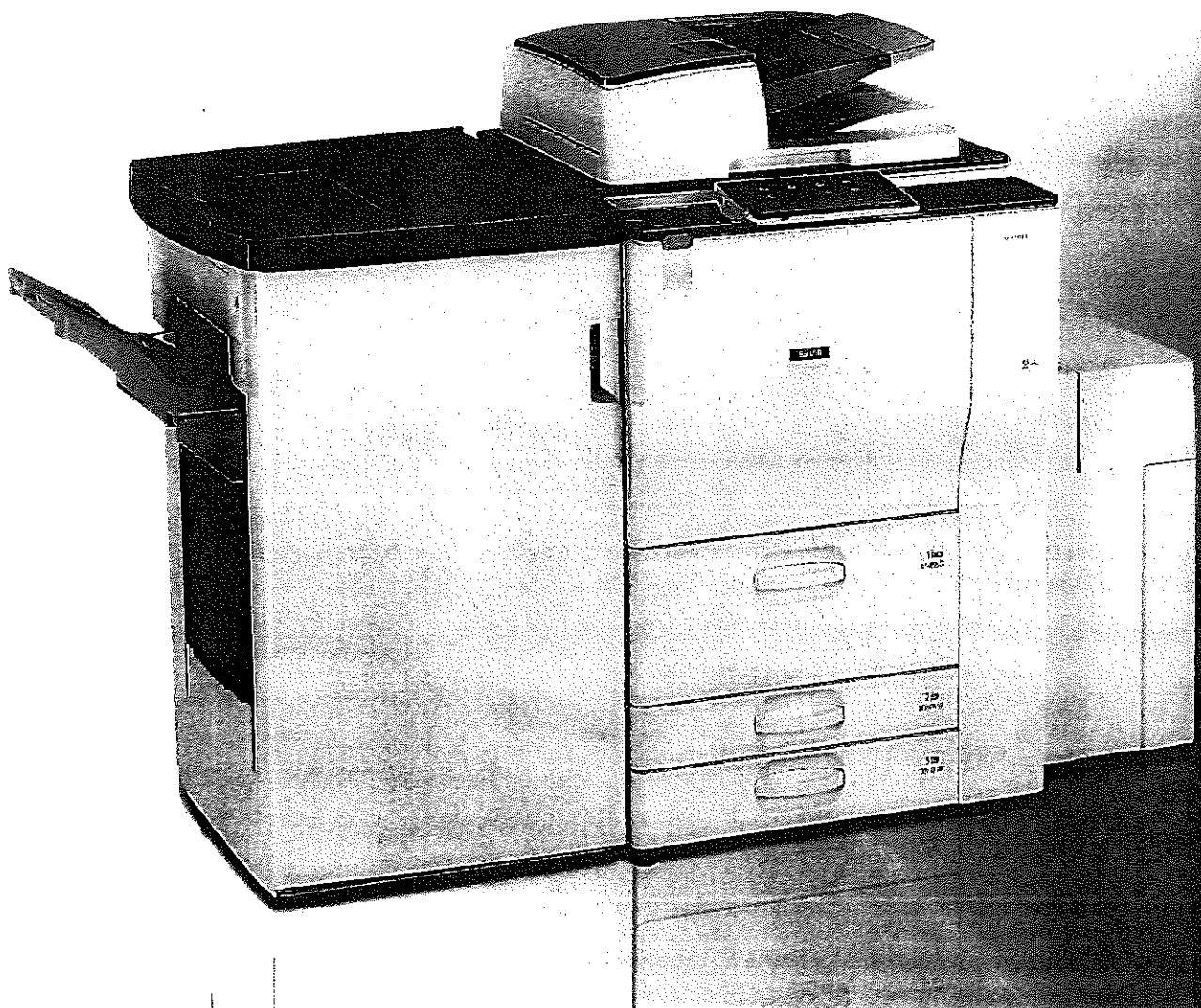

Create new ways to be more productive

Move information in multiple formats quickly and reliably

Perform everyday tasks with ease

If there's one thing you know for certain, more work is on the way. Be prepared for it. Take advantage of print speeds up to 90 pages per minute and expanded paper capacity up to 8,300 sheets to minimize delays and transition between jobs quickly. Schedule larger jobs when the office is quiet to avoid print delays and shorten print queues by bypassing problem print jobs easily with Auto Job Promotion. With its innovative Motion Detection Sensor, the MP 6503/MP 7503/MP 9003 powers up from sleep before you even reach the control panel. Once there, it takes only a few taps to print, scan, copy or fax critical information in multiple formats, with extensive paper handling options.

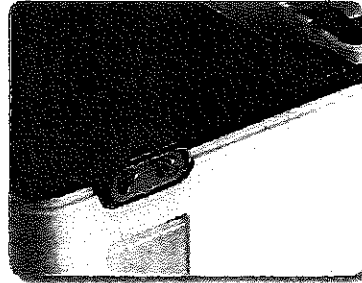

Keep moving and stay productive

Work where you are, whenever you want. Use your smartphone, tablet or laptop to connect to the MP 6503/MP 7503/MP 9003 via wireless LAN and avoid cumbersome utilities, print drivers and software. Just download the Smart Device Connector App to control all print, copy, scan and fax functions from your Android or iOS device. Access digital files directly from your device or Cloud applications and send them to the MFP, where you can release them for safe printing once you arrive. When you want to avoid carrying piles of paperwork, you can simply store files on a USB/SD memory card and plug it into the MFP when ready to print.

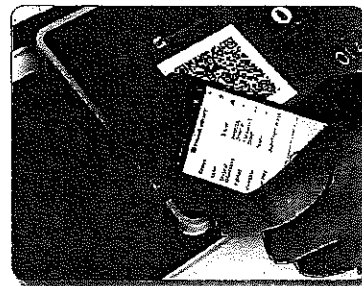

Share information in moments

Timely information leads to better decisions. With the MP 6503/MP 7503/MP 9003, you can use the Single Pass Document Feeder (SPDF) to quickly scan up to 120 single-sided or 220 double-sided images per minute — in color or black-and-white. You don't even have to close it to scan or copy books, pamphlets and magazines. With the Easy Book Copy App you can eliminate shadows in the margins or near the binding. Access LDAP-registered directories right at the device and send to clients, coworkers and other contacts with a single touch using delivery options such as scan-to email/folder/SMB/FTP and more. You can also use your personal address book on your smartphone to expand your list of recipients. Share contracts and other important documents with paperless faxing from your desk or personal mobile device. Forward incoming faxes to specific email addresses to save you the hassle of handling paper transmissions.

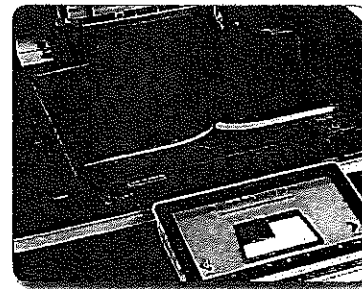

Get in touch with a smarter way to work

Make work more personal

Nobody knows how to do your job as well as you do. Prove it. Use Workstyle Innovation Technology to tailor the MP 6503/MP 7503/MP 9003 to work the way you do. Create customized automated workflows to reduce repetitive tasks and manual errors. Simplify everyday tasks for your mobile workforce. Access information easily from the Cloud. Add one-touch shortcut icons for specific jobs. Best of all, you can do it with ease from the 10.1"-wide Super VGA Smart Operation Panel. Do you share a weekly report with multiple departments? Preset delivery destinations will minimize manual entry steps. Do you check specific information, such as toner levels, paper usage or print queues? Install one of the preloaded widgets on the Home Screen and have the information you need at your fingertips.



Tap into more productivity

We've removed all hard keys from the Smart Operation Panel, so you can enjoy tablet-like functionality and freedom and adjust to everyday workplace changes swiftly and intelligently. Savin's Workstyle Innovation Technology can help you access important details, change settings and move swiftly from one task to the next using the same pinch-and-flip, drag-and-drop and swipe scrolling techniques used on smartphones and tablets. You choose which icons, options and notifications that appear on your unique user interface. Simply tap in and out of easy-to-read displays and get the details you need to make more productive decisions. It's never been easier to perform everyday tasks. Print, copy, scan and fax with a single touch and complete projects with unprecedented speed and convenience. The MFP includes a standard, embedded web browser, so you can access information from your choice of Cloud applications or search for and print information from the Internet at the device.

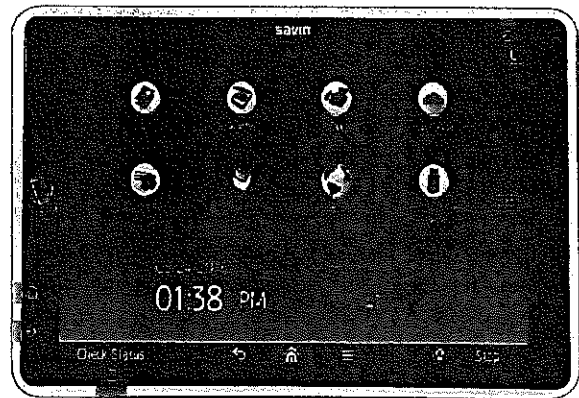

Save time automatically

Store up to 3,000 frequently-used documents on the Document Server and access the files with a tap from the touchscreen. Use optical character recognition (OCR) to make your scanned document files searchable, so you can locate words quickly with a keyword search. The bypass tray can detect paper sizes automatically to simplify printing. When working with two-sided forms like drivers' licenses and insurance cards, you can use the ID Card Copy App to scan both sides and print them on a single-sided sheet of paper. In addition, you can take advantage of several Savin and third-party workflow software applications designed specifically to reduce manual steps and simplify how you share information.



Move information securely and reliably

Stay protected

You want to move information quickly, but not recklessly. With user authentication, you can force users to enter a passcode or billing code before they can use MFP functions. Because it's preconfigured to support Near Field Communication (NFC), you can opt to install an NFC Card Reader on the MFP, which grants access only after users swipe an identity or proximity card. With Locked Print, jobs remain in queue at the device, and out of sight, until the authorized user releases them. You can even pair the MFP with accounting software to issue chargebacks to specific users and departments. Place watermarks on documents to prohibit unauthorized copies of confidential information. Use powerful encryption to protect data on the 320 GB hard disk drive or the DataOverwriteSecurity System (DOSS) to destroy document images on the hard drive.

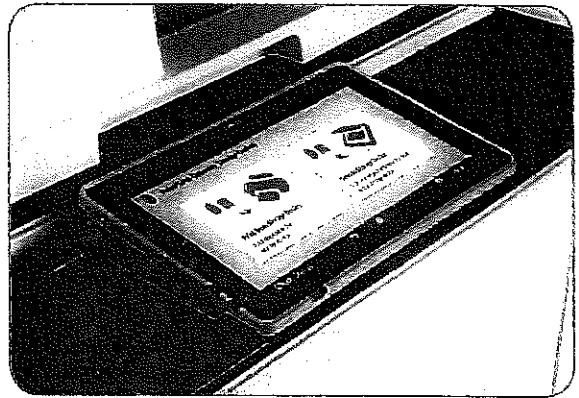

Take administrative control

Maintain productivity and minimize operating costs from a centralized location. Use Device Manager NX to monitor, configure and update via a web browser. Use @Remote to automate service calls and collect important device data, including meter readings and error details. IT managers can install Device Software Manager to automatically update print drivers. Are you worried users are abusing print privileges? Set print quotas for specific users or departments to curb excessive printing and subsequent costs. Is the MFP powered up over long weekends? Shut it down remotely to reduce your energy bill. Are users struggling with a feature or function? Contact our Support Help Desk directly and an experienced representative can access the user interface remotely and simplify troubleshooting.

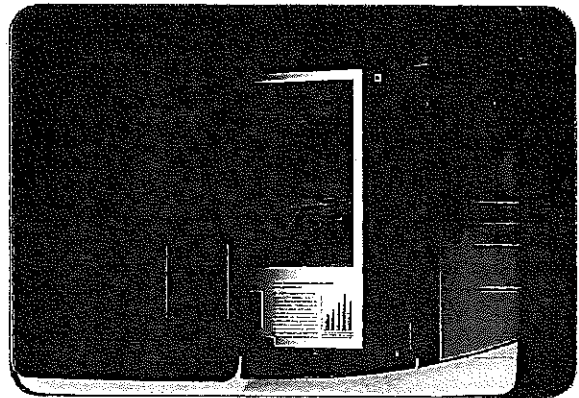

Be responsible

Encourage responsible behavior with eco-friendly features designed specifically to reduce environmental impact and operating costs. Cut paper use and costs with default duplex printing. Save electricity by scheduling the MFP to power off when you know the office is empty — such as overnight or weekends — and reduce energy consumption significantly. Because the MFP meets EPEAT® Gold* criteria and ENERGY STAR® certifications, you can realize low Typical Electricity Consumption (TEC) rates. Track how much you're saving on paper with the convenient Eco-Friendly widget, where you can check usage stats and even share friendly reminders with users.

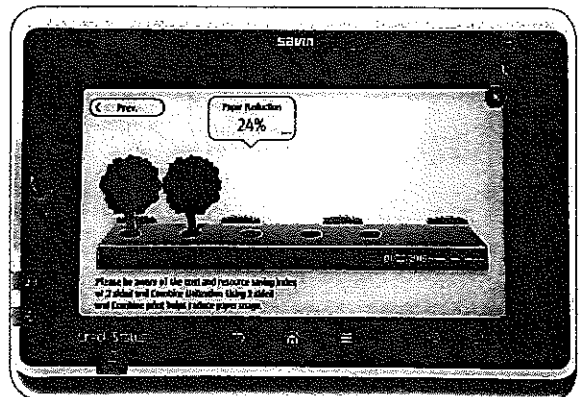

*EPEAT rating is applicable only in the USA.

To view detailed features of our multifunction products online go to www.savin.com/products

Combine power and convenience into a compact design

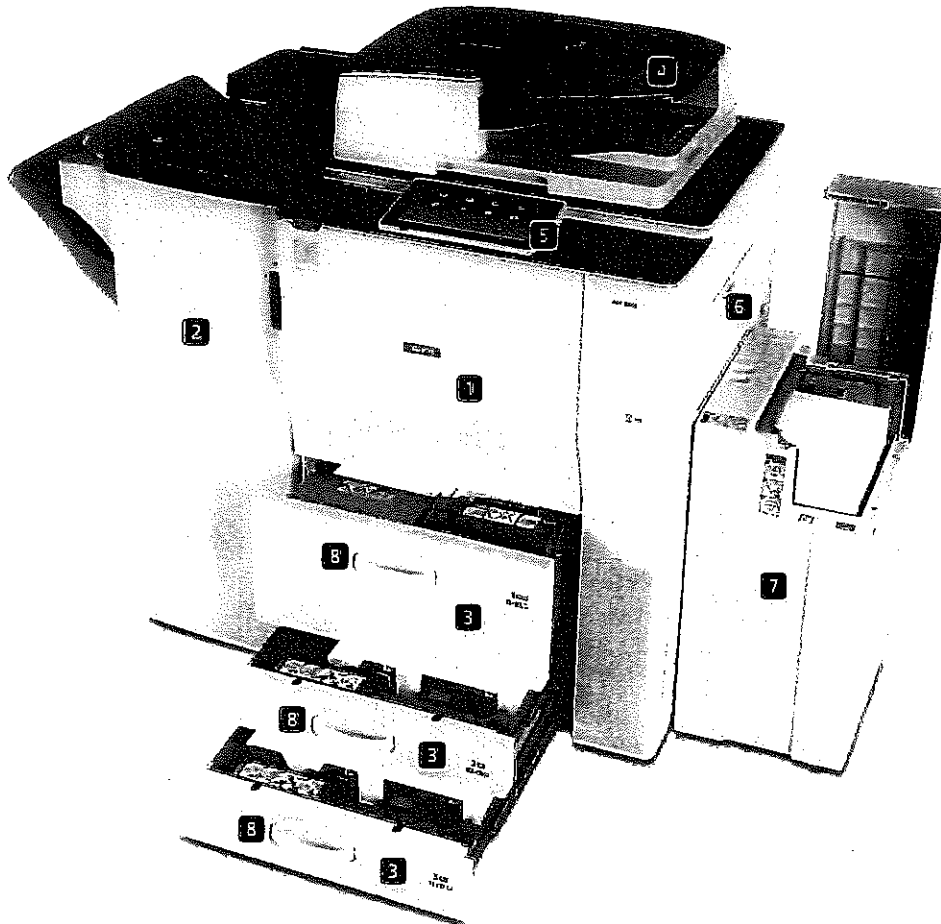

- 1 Base System:** Choose between 65-, 75- or 90-pages-per-minute output speeds to get started.
- 2 Cover Interposer Trays (Optional/not shown):** Feed pre-printed full-color or black-and-white covers and inserts into finishing workflows.
- 3 Multi-Fold Unit FD4000 (Optional/not shown):** Meet a wider range of folding needs — including Half-Fold, Letter Fold-In (Tri-Fold), Letter Fold-Out (Tri-Fold), Gate-Fold, Double Parallel (Four-Fold) and Z-Fold — with the in-line Multi-Fold Unit.
- 4 3,000-Sheet Finisher with 65-Sheet Stapler SR4120 (Optional/shown):** Also choose from two other finishers; a 3,000-Sheet Finisher with 100-Sheet Stapler or a 2,000-Sheet Saddle-Stitch Booklet Finisher with 65-Sheet Stapler (Optional/not shown).
- 5 9-Bin Mailbox CS4010 (Optional/not shown):** Find an abundance of space to separate and stack documents with this convenient 9-Bin Mailbox unit.
- 6 Paper Trays:** Standard paper capacity is 4,300 sheets up to 11" x 17", which includes dual front-loading 550-Sheet Trays and a Tandem Paper Tray that holds 1,550 sheets in each of two compartments.
- 7 Single Pass Document Feeder:** Scan up to 120 single-sided or 220 double-sided color or black-and-white images per minute via the one-pass Duplex Scanning Document Feeder.
- 8 Full-Color 10.1"-wide Super VGA Smart Operation Panel:** Toggle between menus, settings and other controls with touchscreen convenience.
- 9 Bypass Tray:** Feed a wide range of paper stocks, up to 110 lb. Cover, through the 100-Sheet Bypass Tray.
- 10 Large Capacity Tray LCIT4040 (Optional):** Add the 4,000-Sheet Large Capacity Tray (LCT) for 8.5" x 11" paper sizes to expand total paper capacity to a whopping 8,300 sheets.
- 11 Normal/Reverse Grip Handles:** Reload paper quickly and conveniently with easy-grip handles on all paper trays.

Slide right into automated convenience

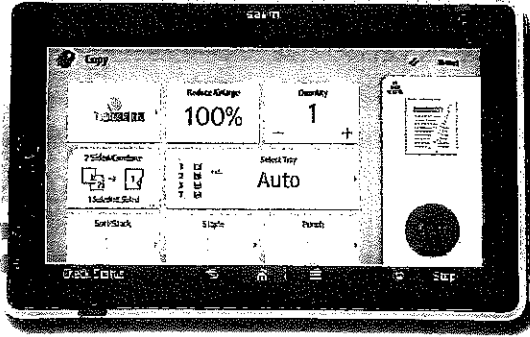

New User Interface: Meet your most unique workflow demands with this intuitive, easy-to-navigate user interface. It's set up in a grid layout, so features can be accessed dynamically. Use the familiar swipe scrolling and pinch-and-flick movements found on most touchscreens. Find key settings and adjust them with the same techniques. Take advantage of its built-in "Cloud solution ready" capabilities. You can even choose which shortcut workflows you want to place on the Home Screen.

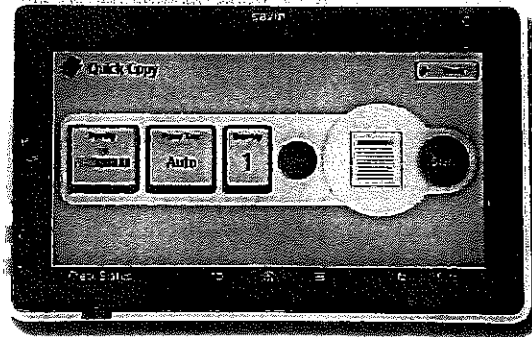

Quick User Interface: There are several functions that almost every user needs, including immediate access to printing, copying, scanning and faxing. Access each with a single touch from the Quick User Interface and expedite common, everyday projects. To access more unique functions, such as ID Card Copy or Scan-to-Folder Helper, you can place these shortcuts on the Home Screen. Just tap it to get started.

Classic (Legacy) User interface: Some people are reluctant to change. Don't worry — we have you covered. You can also still use the legacy user interface on the new touchscreen. Just tap its icon on the Home Screen and begin working with the familiar user interface you are accustomed to.

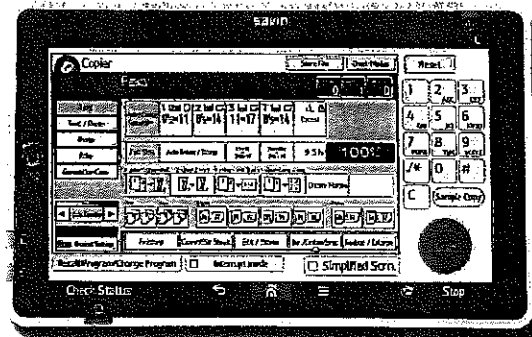

Make it look professional

Add the finishing touches to presentations, reports, briefs and more with a wide range of automated finishers that improve paper handling, stacking and stapling. Each reduces manual tasks, so you can complete jobs in less time with fewer errors. Choose the one that fits your office needs.

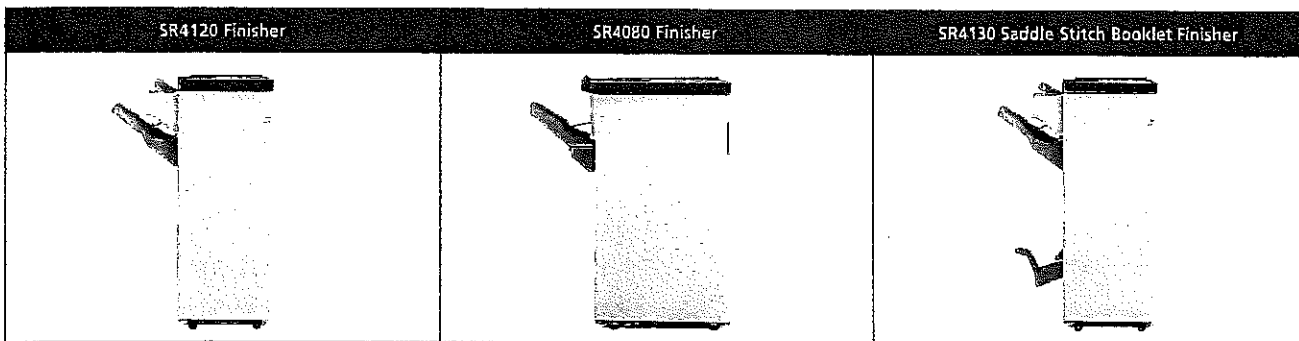

Finisher	Paper Capacity (LT)	Staple Sheet Capacity (LT)	Saddle Stitch	Hole-Punch
SR4120 Finisher	3,000 Sheets	65 Sheets	N/A	Option
SR4080 Finisher	3,000 Sheets	100 Sheets	N/A	Option
SR4130 Saddle Stitch Finisher	2,000 Sheets	65 Sheets	20 Sheets	Option
CS4010 9-Bin Mailbox	100 Sheets/Bin	N/A	N/A	N/A

Savin MP 6503/MP 7503/MP 9003

STYLISH. EFFICIENT. FAST.



General Specifications

Memory (RAM)	2 GB
HDD	320 GB
First Copy Time	MP 6503/MP 7503: 3.2 seconds MP 9003: 2.9 seconds
Warm-Up Time from Main Switch	MP 6503/MP 7503: 20 seconds
Copy Speed	MP 9003: 300 seconds 65/75/90 copies/minute multiple sets (Letter LEF)
Original Size	Up to 11" x 17"
Copy Size	5.5" x 8.5" - 11" x 17"
Copy Resolution	True 600 x 600 dpi
Zoom	25% - 400% in 1% increments
Paper Capacity	Standard: Tray 1: 1,550 sheets x 2 (Tandem) = 3,100 (Letter) Trays 2 & 3: 550 sheets each (user adjustable) Bypass: 100 sheets Total Standard/Max: 4,300/8,300 sheets
Paper Weight	Trays 1 - 3: 52 - 256 g/m ² (14 lb. Bond - 68 lb. Bond) Bypass Tray: 52 - 300 g/m ² (14 lb. Bond - 111 lb. Cover) Duplex Unit: 64 - 256 g/m ² (17 lb. Bond - 95 lb. Cover)
Power Requirements	MP 6503/MP 7503: 120-127V/60Hz/20A (Requires dedicated 20A outlet) MP 9003: 208-240V/60Hz/12A (Requires dedicated 20A outlet)
Typical Electricity Consumption (TEC)	MP 6503: 4.9 kWh MP 7503: 5.4 kWh MP 9003: 12.5 kWh
Dimensions (WxDxH)	27.2" x 31.6" x 45.7" (690 x 803 x 1161 mm)
Weight	441 lbs. (200 kg)
Single Pass Document Feeder (SPDF) Standard	
Original Size	5.5" x 8.5" - 11" x 17"
Paper Weight	Simplex: 11 lb. - 34 lb. Bond (40 - 128 g/m ²) Duplex: 14 lb. - 34 lb. Bond (52 - 128 g/m ²) 220 sheets (based on 21 lb. Bond - 81.4 g/m ²)
Capacity	

Options

LCIT4040 Large-Capacity Tray (LCT)	
Paper Size	8.5" x 11" /A4 (LEF)
Paper Weight	14 - 34 lb. Bond (52 - 128 g/m ²)
Paper Capacity	4,000 sheets (20 lb. Bond - 75 g/m ²)
Dimensions (WxDxH)	12.36" x 18.03" x 25.94" (314 x 458 x 659 mm)
8.5" x 14" Paper Size Tray Type 9002	
Enables legal-size (8.5" x 14") paper to be fed through LCT	
Paper Size	8.5" x 14" /B4, 8.5" x 11" /A4 SEF
Paper Capacity	2,500 sheets (20 lb. Bond - 75 g/m ²)
CS4010 9-Bin Mailbox	
Compatible with SR4120 and SR4130 Finishers	
Number of Bins	9
Stack Capacity	100 sheets/bin (20 lb. Bond - 75 g/m ²)
Paper Size	5.5" x 8.5" - 11" x 17"
11" x 17" Tray Type 9001	
Enables 8.5" x 11" - 11" x 17" paper to be fed from Tray 1	
Paper Size	11" x 17" SEF, 8.5" x 14" SEF, 8.5" x 11" SEF
Paper Capacity	1,000 sheets
Cover Interposer Tray Options	
Paper Size	5.5" x 8.5" - 11" x 17"
Paper Weight	17 lb. Bond - 110 lb. Index (64 - 216 g/m ²)
Paper Capacity	200 sheets (20 lb. Bond - 75 g/m ²)
Tray Type CI4030 Compatible with SR4080 Finisher	
Tray Type CI4040 Compatible with SR4120 Finisher or SR4130 Booklet Finisher	
Punch Unit PU3060	
Compatible with SR4120 Finisher and SR4130 Booklet Finisher	
Hole Positions	2 or 3 holes
Paper Size	5.5" x 8.5" - 11" x 17"
Paper Weight	14 lb. Bond - 142 lb. Index (52 - 256 g/m ²)
FD4000 Multi-Folding Unit	
Compatible with all finishers	
Folding Type	
Single Sheet Mode	Z-Fold, Half-Fold, Letter Fold-In, Letter Fold-Out, Double Parallel, Gate-Fold
Multiple Sheets Mode	Half-Fold, Letter Fold-In, Letter Fold-Out, Up to 3 sheets
Paper Size	
Single Sheet Mode	Z-Folding: 8.5" x 11" - 11" x 17" Half-Folding: 8.5" x 11" - 11" x 17" Letter Folding: 8.5" x 11" - 11" x 17"

Double Parallel/Gate-Folding: 8.5" x 11"	
Multiple Sheets Mode: Half-Folding: 8.5" x 11" - 11" x 17"	
Letter Folding: 8.5" x 11"	
SR4130 2,000-Sheet Saddle-Stitch Finisher with 65-Sheet Stapler	
Proof Tray	
Paper Size	5.5" x 8.5" - 11" x 17" (A5 - A3) SEF
Paper Weight	14 lb. Bond - 121 lb. Index (52 - 220 g/m ²)
Stack Capacity	250 sheets (8.5" x 11" or smaller) 50 sheets (8.5" x 14" or larger)
Shift Tray	
Paper Size	5.5" x 8.5" - 11" x 17" (A5 - A3) SEF
Paper Weight	14 lb. Bond - 111 lb. Cover (52 - 300 g/m ²)
Stack Capacity	2,000 sheets (8.5" x 11" LEF) 1,000 sheets (8.5" x 11" SEF, 8.5" x 14" SEF, 11" x 17" SEF) 500 sheets (5.5" x 8.5" LEF) 100 sheets (5.5" x 8.5" SEF)
Staple Capacity	Same Paper Size: 65 sheets (8.5" x 11" - 11" x 17") Mixed Paper Size: 65 sheets (8.5" x 11", 11" x 17") Saddle-Stitch: 20 sheets (8.5" x 11" SEF, 8.5" x 14" SEF, 11" x 17" SEF) Staple Position: Top, Bottom, 2 Staples, Top Slant, Booklet
Dimensions (WxDxH)	25.9" x 28.7" x 38.6" (657 x 730 x 980 mm)
SR4080 3,000-Sheet Finisher with 100-Sheet Stapler	
Proof Tray	
Paper Size	5.5" x 8.5" - 11" x 17" (A5 - A3) SEF
Paper Weight	14 lb. Bond - 80 lb. Cover (52 - 216 g/m ²)
Stack Capacity	500 sheets (8.5" x 11" or smaller) 250 sheets (8.5" x 14" or larger)
Shift Tray	
Paper Size	5.5" x 8.5" - 11" x 17" (A5-A3) SEF
Paper Weight	14 lb. Bond - 110 lb. Index (52 - 216 g/m ²)
Stack Capacity	3,000 sheets (8.5" x 11" LEF) 1,500 sheets (8.5" x 11" SEF, 8.5" x 14" SEF, 11" x 17" SEF) 500 sheets (5.5" x 8.5" LEF) 100 sheets (5.5" x 8.5" SEF)
Staple Capacity	Same Paper Size: 100 sheets (8.5" x 11") 50 sheets (8.5" x 14", 11" x 17") Mixed Paper Size: 50 sheets (8.5" x 11" LEF, 11" x 17" SEF) Staple Positions Top, Top Slant, Bottom, 2 Staples 31.5" x 28.7" x 38.6" (800 x 730 x 980 mm)
Dimensions (WxDxH)	
Punch Unit Type 1075	
Hole Positions	2 or 3 holes
Paper Size	5.5" x 8.5" - 11" x 17"
Paper Weight	14 lb. Bond - 90 lb. Index (52 - 162 g/m ²)
SR4120 3,000-Sheet Finisher with 65-Sheet Stapler	
Proof Tray	
Paper Size	5.5" x 8.5" - 11" x 17" (A5 - A3) SEF
Paper Weight	14 lb. Bond - 121 lb. Index (52 - 220 g/m ²)
Stack Capacity	250 sheets (8.5" x 11" or smaller) 50 sheets (8.5" x 14" or larger)
Shift Tray	
Paper Size	5.5" x 8.5" - 11" x 17" (A5 - A3) SEF
Paper Weight	14 lb. Bond - 111 lb. Cover (52 - 300 g/m ²)
Stack Capacity	3,000 sheets (8.5" x 11" LEF) 1,500 sheets (8.5" x 11" SEF, 8.5" x 14" SEF, 11" x 17" SEF) 500 sheets (5.5" x 8.5" LEF) 100 sheets (5.5" x 8.5" SEF)
Staple Capacity	Same Paper Size: 65 sheets (8.5" x 11" - 11" x 17") Mixed Paper Size: 65 sheets (8.5" x 11", 11" x 17") Top, Bottom, 2 Staples, Top Slant
Staple Positions	
Dimensions (WxDxH)	25.9" x 28.7" x 38.6" (657 x 730 x 980 mm)
Print Controller Specifications	
CPU	Intel® Atom Process BayTrail-1 1.75 GHz
Host Interface	Standard: 10Base-T/100Base-TX/1000Base-T Ethernet, SD Card Slot (1 Slot/Support SDHC Memory Card), USB Host (Type A: 1 Port/Support USB Flash Memory) Optional: IEEE 1284, Wireless LAN (IEEE 802.11 a/b/g/n), USB Device (Type B: 1 Port) TCP/IP (IPv4/IPv6)
Network Protocol	2 GB
Memory Capacity	Standard: PCL5e, PCL6, PDF Direct Print Optional: Adobe® PostScript®3™, IPDS, XPS
PDL	

Print Resolution	Up to 1200 x 1200 dpi
Fonts	Standard: PCL: 45 scalable, 6 bitmapped, 13 International Option: PPS: 136 Roman; IPDS: 108 Roman Windows Vista®/7/8, 1/10Server 2003/2003 R2/2008/2008 R2/2012/2012 R2 Unix: Sun Solaris, HP-UX, SCO OpenServer, Red Hat Linux, IBM AIX Citrix Presentation Server 4.5/Citrix XenApp 5.0 Mac OS X v.10.7 or later; SAP R/3; IBM iSeries/AS/400-using OS/400 Host Print Transform
Operating System	
Scanner Specifications	
Scan Speed	Full-Color, 88W 200 dpi (LT): 120 ipm (Simplex)/220 ipm (Duplex) 88W 300 dpi (LT): 120 ipm (Simplex)/220 ipm (Duplex) Full-Color 300 dpi (LT): 120 ipm (Simplex)/210 ipm (Duplex)
Optical Resolution	100 dpi - 600 dpi (100 - 1200 dpi with TWAIN); Default: 200 dpi
Output Format	Single Page: TIFF, JPEG, PDF, High Compression PDF, Digital Signature PDF, PDF/A Multi Page: TIFF, PDF, High Compression PDF, Secure PDF, Digital Signature PDF, PDF/A Standard: 10Base-T/100Base-TX/1000Base-T Ethernet Optional: IEEE 802.11a/b/g/n Wireless LAN Network TWAIN Driver
Interface Support	Secure PDF, Digital Signature PDF, PDF/A Standard: 10Base-T/100Base-TX/1000Base-T Ethernet Optional: IEEE 802.11a/b/g/n Wireless LAN Network TWAIN Driver
Drivers	Yes (up to 500 addresses per send)
Scan-to-Email	Yes (Version 3)
LDAP Support	2,000
Max Stored Destinations	SMTP/POP before SMTP
Authentication	Yes (up to 50 folders per job)
Scan-to-Folder	SMB, FTP
Protocol Support	USB/SD Card
Scan-to-Media	
Facsimile Specifications (Optional)	
Type	ITU-T (CITT) G3, Additional G3 (Optional)
Circuit	PTSN, PBX
Resolution	200 x 100 dpi (Standard Mode); 200 x 200 dpi (Detail Mode); 400 x 400 dpi (Super Fine Mode; available with optional SAF memory)
Modern Speed	33.6 Kbps with auto fallback
Compression Method	MH, MR, MMR, JBIG
G3 Transmission Speed	Approximately 2 seconds/page (with JBIG); Approximately 3 seconds/page (with MMR)
Auto Dialing	2,000 Quick Dials, 100 Group Dials
SAF Memory Capacity	Standard: 4 MB (Approximately 320 pages); Maximum: 64 MB (approximately 4,800 pages) with memory option
Additional Modes	Internet Fax by e-mail (T.37), IP Fax (T.38), LAN Fax, Fax Forward to E-mail/Folder, LDAP support
Options	G3 Interface Unit Type M25 (provides one additional G3 line; up to two lines may be added for a maximum of three lines); Memory Unit Type M25 (64 MB for fax option), Fax Connection Unit Type M25
Accessories	
Output Jogger Unit Type M25 (for SR4120/SR4130), Output Jogger Unit Type 9002B (for SR4080), Tab Sheet Holder Type 9002, PostScript3 Unit Type M25, IPDS Unit Type M25, XPS Direct Print Option Type M25, Copy Tray Type 9002, IEEE802.11a/g/n Interface Unit Type M19, IEEE1284 Interface Board Type M19, Extended USB Board Type 19, DataOverwritesecurity Unit Type M19, OCR Unit Type M13, Counter Interface Unit Type M12, Smart Card Reader Built-in Unit Type M19, NFC Card Reader Type M19, Card Reader Bracket Type 3352, Copy Connector Type M25, File Format Converter Type M19	
Some options may not be available at the time of market release. Specifications are subject to change without notice.	
For maximum performance and yield, we recommend using genuine Savin parts and supplies.	

www.savin.com

Ricoh USA, Inc., 20 Valley Stream Parkway, Malvern, PA 19355, 1-877-472-6460
Savin® and the Savin logo are registered trademarks of Ricoh USA, Inc. Ricoh® and the Ricoh logo are registered trademarks of Ricoh Company Ltd. All other trademarks are the property of their respective owners. ©2017 Ricoh USA, Inc. All rights reserved. Savin products and services are offered by Ricoh USA, Inc. and its affiliates. The content of this document, and the appearance, features and specifications of Savin products and services are subject to change from time to time without notice. Products are shown with optional features. While care has been taken to ensure the accuracy of this information, Ricoh makes no representation or warranties about the accuracy, completeness or adequacy of the information contained herein, and shall not be liable for any errors or omissions in these materials. Actual results will vary depending upon use of the products and services, and the conditions and factors affecting performance. The only warranties for Savin products and services are as set forth in the express warranty statements accompanying them.

SAVIN®

Pro 8210s/ 8220s/8210/ 8220

B&W Production Printer

- Printer
- Copier
- Facsimile
- Scanner

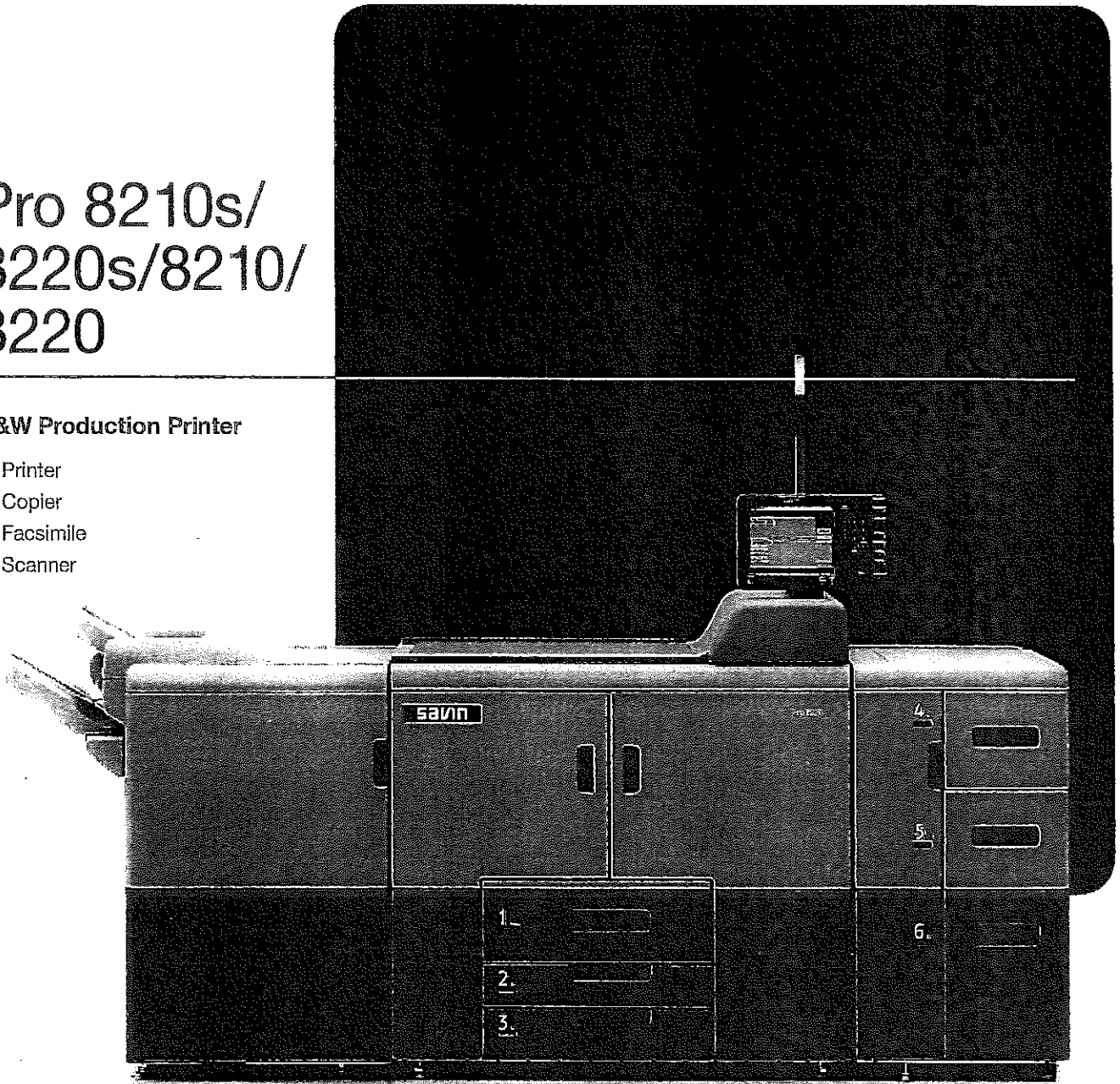

It's never been easier to grow your print business

Simplify the way you print with superior performance from the SAVIN® Pro 8210s/8220s multifunction production printer or SAVIN Pro 8210/8220 production printer. Deliver high-speed black-and-white documents and give your customers more print options so you can capture more of their business. Impress with high-quality newsletters, advertisements, bulletins, direct mail and much more on diverse media, including thicker paper stocks and larger sizes. Choose from multiple automated finishers to give every document a polished, professional look. Create automated shortcuts and utilize preconfigured settings quickly to save time. Change consumables and make adjustments on the fly. And do it all with intuitive controls that help you simplify the most complex workflows and meet the tightest deadlines.

- Produce black-and-white documents at up to 136 ppm
- Create compelling output with image resolution up to 1200 x 4800 dpi
- Print on media, including heavy and textured stock, up to 13" x 19.2"
- Send information electronically via several scan-to capabilities
- Expand paper capacity up to 12,650 sheets to extend print runs
- Automate finishing to produce professional results in less time

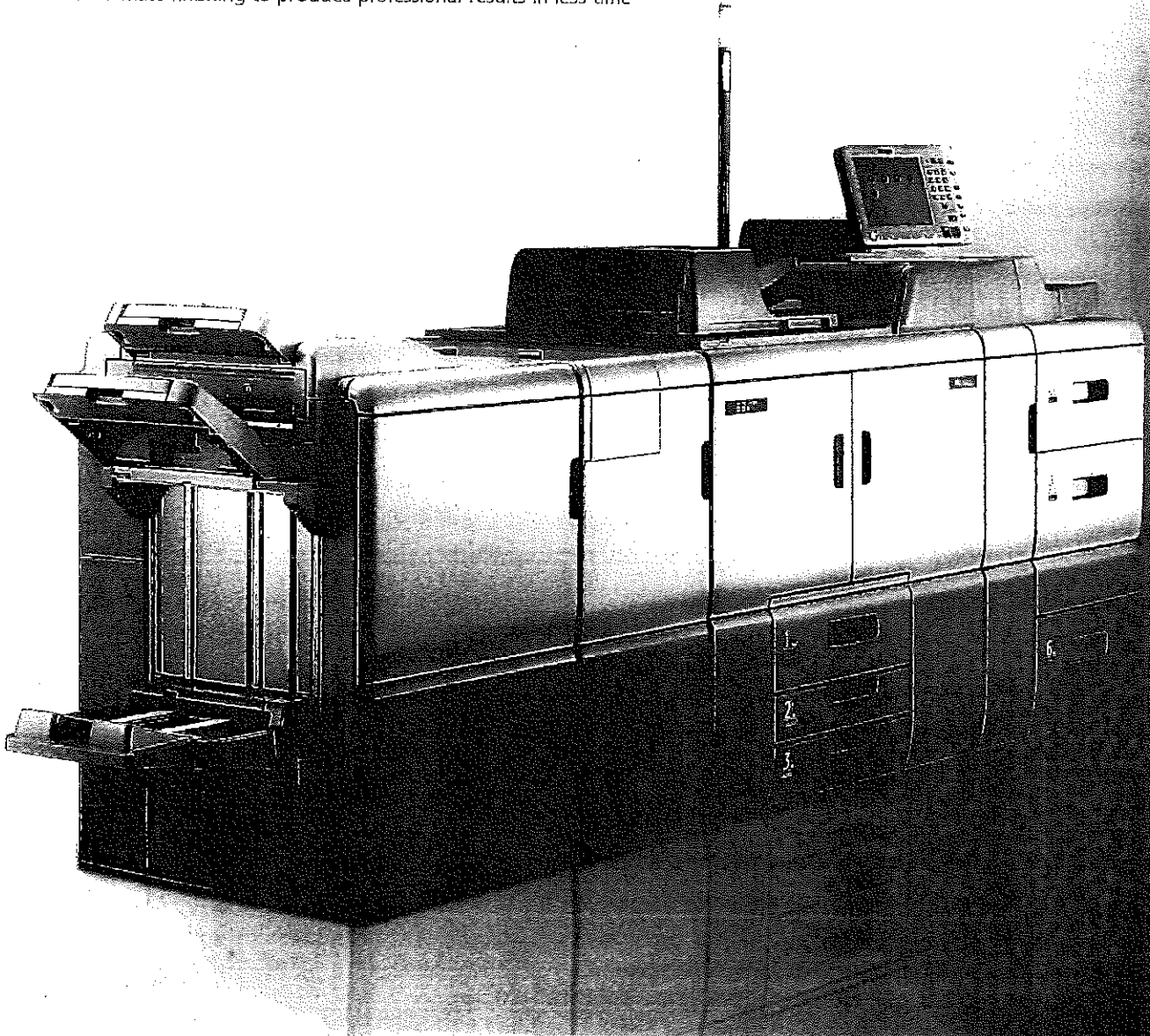

Meet more deadlines, realize more opportunities

Simplify high-volume, low-stress production printing

Let productivity lead to profitability

Use the Pro 8200 Series to print up to 136 pages per minute and meet more deadlines — so you can capture more revenue-generating opportunities. Add optional paper trays for up to nine types of media and 12,650 sheets total paper capacity to target more types of customers and jobs. Reload toner and media on the fly with dual toner cartridges and Active Tray Indicator lights. Keep tabs on system status from anywhere on the production floor via the Operator Call Light. Trained Customer Replaceable Units (TCRUs) provide all the necessary critical components on-site for easy replacement without service technician support.

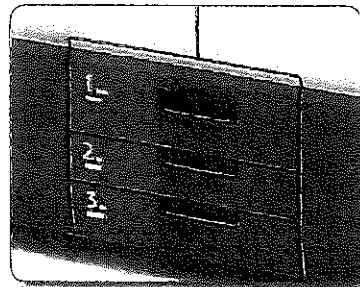

Get innovative with more media choices

Choose from a wide range of media options to make your documents stand out. Print at sizes up to 13" x 19.2" for closer views of manuals and drawings. Use heavily-coated stocks up to 350 g/m² for attention-grabbing direct mail, postcards, brochures, newsletters and more. Quickly set up and print up to 13" x 27.5" uncoated book covers and composites with the optional Multi Bypass Banner Sheet Tray. Take advantage of standard support for No-Carbon Required (NCR) paper to keep production of this important workflow in-house. You can also print checks with the magnetic ink character recognition (MICR) option to expand your client list even more. It uses Rosetta's patented dual component ProMark™ 8100 MICR toner and optimized E-13B and CMC-7 MICR fonts to stand up to the punishment of dozens of passes through high speed reader-sorter machines.

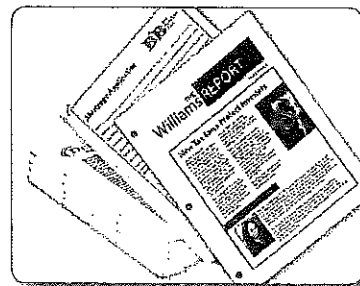

Create with clarity

Impress your customers with extremely high-quality output at up to 1200 x 4800 dpi resolution. The Pro 8200 Series uses more granular toner particles, so you can create photo-like images with smoother gradations and halftones. The system also delivers consistent front-to-back registration for precise alignment from the first print to the last on books, manuals, directories, brochures, postcards and other documents.

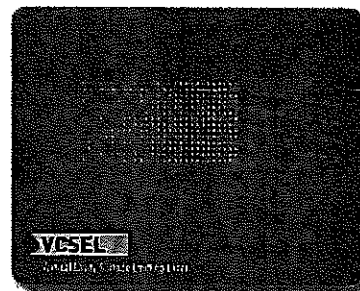

More features to manage more types of jobs

- 1 HCB500 Plockmatic High Capacity Interposer (Optional):** Feed pre-printed sheets from two sources for front and back covers. Insert a wide range of offset, color or coated paper up to 350 g/m² within a single booklet automatically. Take advantage of two trays with 3,500-sheet total paper capacity for extended runs with multiple paper stocks.
- 2 SR5050 3,000-Sheet Staple Finisher (Optional):** Perform up to 100-sheet stapling for documents up to 13" x 19.2". Add flexibility with the optional Hole Punch Unit.
- 3 SR5060 2,500-Sheet Booklet Finisher (Optional):** Use the in-line Booklet Finisher, as well as an optional Booklet Trimmer Unit or Hole Punch Unit, to produce stapled and saddle-stitched booklets cost-effectively.
- 4 DUS050 Decurl Unit (Optional):** Reduce paper curling for more accurate stacking and greater throughput.
- 5 220-Sheet Automatic Document Feeder (Pro 8210s/8220s only):** Expedite copy and scan jobs with single-pass color duplex scanning up to 220 images per minute.
- 6 BY5010 Multi Bypass Tray (Optional):** Add up to 550 sheets of unique stocks and sizes. Produce banners, included on uncoated paper, up to 13" x 27.5" with an optional Multi Bypass Banner Sheet Tray.
- 7 Full-Color, 10.4" SVGA Control Panel:** Perform everyday print tasks with ease and customization and transition from job to job quickly from the post-mounted, intuitive touch screen.
- 8 Operator Call Light:** Find out instantly from anywhere in the print center the moment the printer's status changes.
- 9 VCSEL and Granular Toner Technology:** Produce more vivid prints and smoother gradations for improved text, fine lines, graphics and photographic reproductions via Vertical Cavity Surface Emitting Laser and more uniform toner.
- 10 Heavy Media Support:** Produce 13" x 19.2" output with heavy media (up to 130 lb. Cover through the RT5100 LCIT) to expand in-house production deliverables.
- 11 Paper Trays:** Perform longer runs with tandem 2 x 1,100-Sheet Paper Trays and two 550-Sheet Paper Trays for a standard total paper capacity of 3,300 sheets. Add optional paper sources to expand capacity to 12,650 sheets.

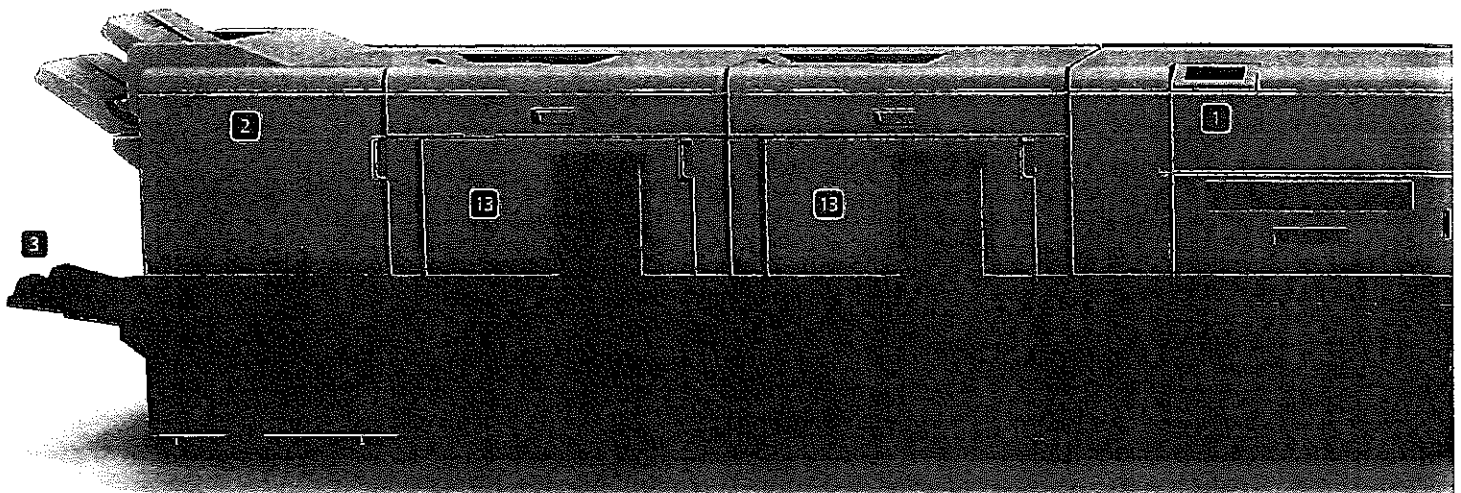

Savin Pro 8220s

12 Active Tray Indicators: See which tray is in use quickly, so you can refill other paper sources without interrupting print jobs.

13 SK5030 High-Capacity Stacker (Optional): Use the 5,000-Sheet Stacker to run longer unattended jobs. Move large volumes of output to off-line binding, packing and shipping quickly via the rollaway cart. Lock the stacker door when printing confidential documents.

14 TK5010 A3/DLT Tray Kit (Optional): Expand paper capacity for larger sizes without taking up too much space by converting a standard paper drawer to an 11" x 17" drawer.

15 RT5100 Vacuum Feed Large Capacity Input Tray (Optional): Support a wider range of media with a three-belt air-delivery system and feed coated papers from 40 – 350 g/m² with speed and accuracy. Add an optional BU5010 Bridge Unit and two 4,400-Sheet Vacuum Feed LCTs to maximize total paper capacity at 12,650 sheets.

Energy Efficiency: Perform tasks using less energy. The device is ENERGY STAR® certified and meets EPEAT® Gold* criteria to help minimize operating costs while reducing environmental impact.

*EPEAT Rating is applicable only in the USA.

Versatile Controller Support: Use the standard print controller to perform everyday print and workflow tasks quickly. Take advantage of PCL5e/6 as standard PDL support and optional genuine Adobe PostScript 3 and genuine IPDS to integrate seamlessly into almost any host environment with incredible reliability and page-recovery capabilities.

Fiery® EB-34 Controller (Optional): Execute end-to-end automated workflows and simplify advanced print management to expand production printing. Based on EFI's popular Fiery Server technology, this digital front end (DFE) controller offers more capabilities including Advanced Job Re-order and Tab Inserts. Plus, you can integrate its Paper Catalog feature with the MFP or printer's Paper Library function to instantly synchronize a print job's custom paper settings.

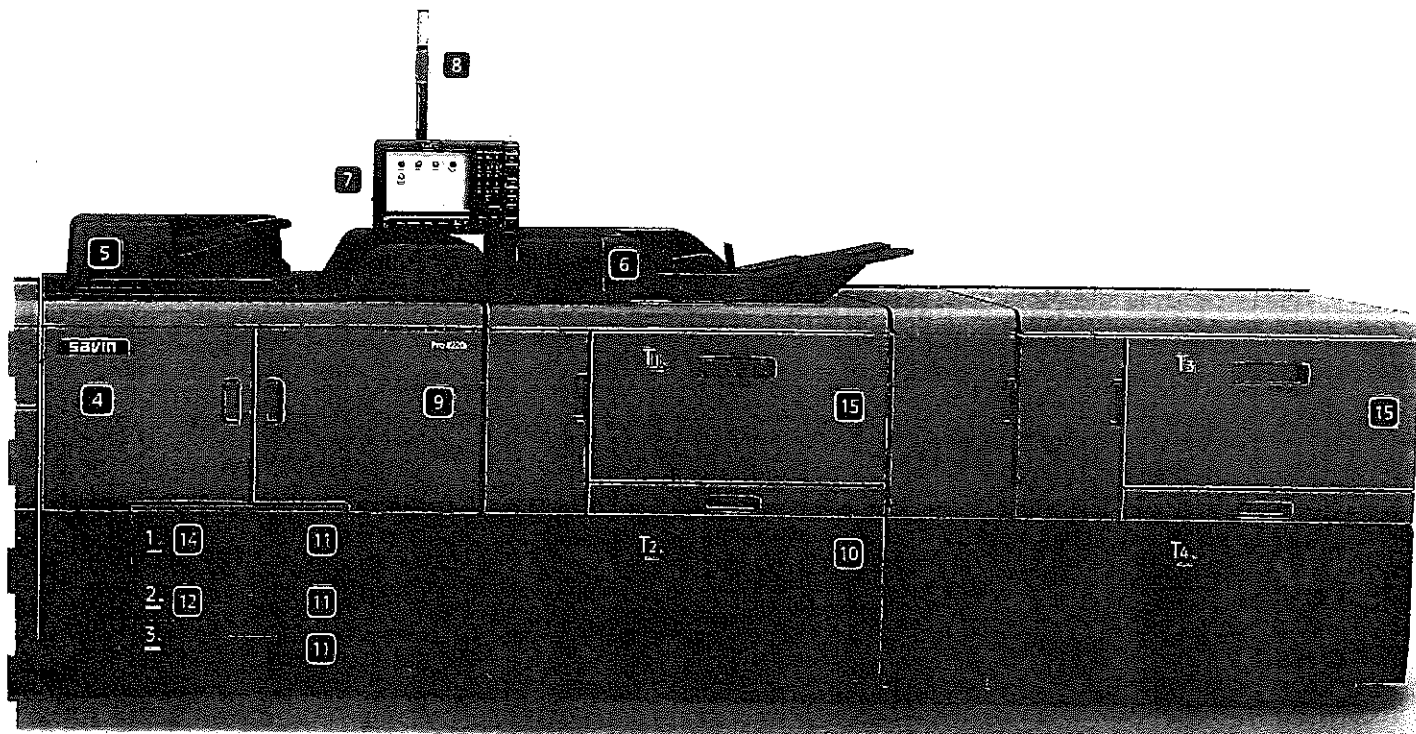

To view detailed features of our B&W production products online go to www.savin.com/products

Make a big production out of productive printing

Transition to digital quickly

Use the Pro 8210s/8220s multifunction production printer/copier/scanner to transform hardcopy documents into digital files and share them instantly right from the control panel. Scan two-sided documents at up to 220 images per minute and send them via Scan-to-E-mail, FTP, PDF, URL and other scan-to options so your clients can preview prints instantly or receive important information for faster, smarter decision-making. Or, you can scan files to a USB or SD card and deliver the files to your clients directly for greater mobility.

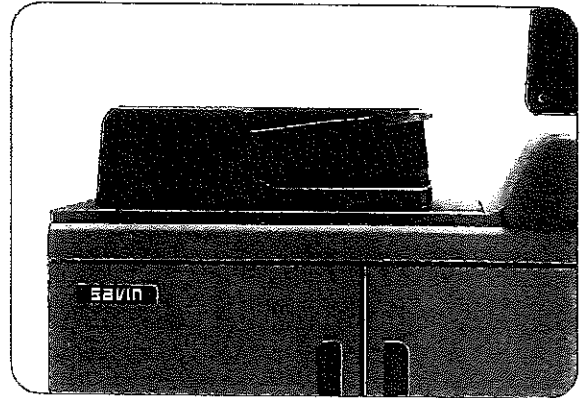

Control workflows to simplify workloads

Now you can focus more on growing your business instead of setting up print jobs. For example, use preconfigured print settings to automate routine steps. Select frequently run jobs from the device's Document Server instantly to save time. Use the optional Fiere® EB-34 Controller and integrate seamlessly with your Paper Library to access dozens of preset paper settings just as quickly. Plus, you can add RICOH TotalFlow® Prep, Print Manager, Production Manager, Path and BatchBuilder software to automate repetitive tasks, minimize manual touchpoints and simplify workflows for even the most complex commercial, CRD or high-volume print jobs.

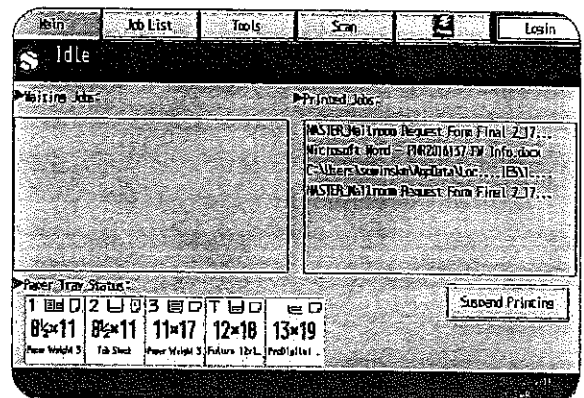

Impress at the finish

Choose from a wide range of options to give every job a polished, professional look while minimizing manual labor, errors and expense. Add automated stapling, saddle-stitching and de-curling to streamline production for booklets, presentations, newsletters, brochures and more. Automate multiple fold options to add another dimension for your direct mail jobs. Use the powerful ring binder for up to 50- to 100-Sheet ring-bound sets or the Plockmatic High Capacity Interposer to add pre-printed inserts from two sources. Take advantage of the Savin booklet finisher and its limitless output mode, so you can work continuously to maximize revenue opportunities. Or, use Savin's Peripheral Interface Port (RPIP) to connect with industrial finishing options such as the C.P. Bourg® BM-e Booklet Maker, Duplo DBM-350 Booklet Maker or Watkiss PowerSquare™ 224 Booklet Maker. Additional manufacturer's production finishing devices will also be certified for in-line connection with Savin's RPIP.



Savin Pro 8210s/8220s/8210/8220

ENR 1000/1001/100BASE-TX

Engine Specifications

Configuration	Console
Standard Modes	Pro 8210s/8220s -- Copy/Print/Scan Pro 8210/8220 -- Print
Print/Copy Process	Electrostatic transfer with indirect image transfer system
Fusing	Oil-less belt fusing method
System Memory	2GB RAM / 640 GB (320 x 2) HDD
Document Feeder	Standard 220-Sheet ADF with single-pass color duplex scanning (Pro 8210s/8220s only)
Control Panel	Full-color 10.4" SVGA touch panel
Copy Resolution	Up to 1200 x 4800 dpi
Paper Registration	Sensor and Mechanical
Quantity Indicator	1 - 9,999
Original Size	Up to 11" x 17" (297 x 432 mm) (from platen)
Warm-Up Time	Less than 360 sec. (from main switch)
First Copy Speed	Pro 8210s/8220: 5.6 seconds Pro 8220s/8220: 4.6 seconds
Output Speed	Pro 8210s/8220: 111 ppm Pro 8220s/8220: 136 ppm
ADF Speed	Simplex: 120 ipm; Duplex: 220 ipm (B&W or Full-color)
Paper Capacity	Tray 1: 2,200 sheets (1,100 x 2) Trays 2 - 3: 1,100 sheets (550 x 2) Trays 4 - 6 with optional A4/LT LCT: 5,000 sheets Trays 4 - 6 with optional A3/DIT LCT: 4,400 sheets Vacuum-Feed LCT Trays (optional): 4,400 sheets Bypass Tray: 550 sheets Total Standard Capacity: 3,300 sheets Total Optional Capacity: 12,650 sheets (with RT5100 LCTs)
Limitless Paper Supply	Supported
Paper Size	Tray 1: 8.5" x 11" Trays 2 - 3: 5.5" x 8.5" to 13" x 18" Trays 4 - 6 with optional A4/LT LCT: 5.5" x 8.5" to 8.5" x 11" Trays 4 - 6 with optional A3/DIT LCT: 5.5" x 8.5" to 13" x 19.2" Vacuum-Feed LCT Trays: 5.5" x 8.5" to 13" x 19.2" Bypass Tray: 5.5" x 8.5" to 13" x 19.2"; Custom Size: 3.94" x 5.5" to 13" x 19.2"
Paper Weight	Trays 1 - 3: 14 lb. Bond - 95 lb. Cover (52 - 256 g/m ²) Trays 4 - 5 with optional A4/LT LCT: 14 lb. Bond - 80 lb. Cover (52 - 216 g/m ²) Tray 6 with optional A4/LT LCT: 14 lb. Bond - 60 lb. Cover (52 - 163 g/m ²) Trays 4 and 6 with optional A3/DIT LCT: 14 lb. Bond - 95 lb. Cover (52 - 256 g/m ²) Tray 5 with optional A3/DIT LCT: 11 lb. Bond - 110 lb. Cover (40 - 300 g/m ²) Vacuum-Feed LCT: 11 lb. Bond - 130 lb. Cover (40 - 350 g/m ²) simplex; 14 lb. Bond - 110 lb. Cover (52 - 300 g/m ²) duplex Bypass Tray: 14 lb. Bond - 80 lb. Cover (52 - 216 g/m ²)
Output Capacity	Finisher: 3,000 + 250 sheets Booklet Finisher: 2,500 + 250 sheets Stacker: 5,000 + 250 sheets
Max. Print Area	12.6" x 18.9" (320 x 480 mm)
Paper Types	Plain, Recycled, Colored, Letterhead, Preprinted, Prepunched, Bond, Card, OHP*, Tab*, Label*, Gloss*, Matte*, Envelope*, NCR*

Magnification	7 reduction and 5 enlargement
Zoom	25% to 400% in 1% increments
Power Requirements	208-240 V, 50/60 Hz, 20 A (dedicated)
Typical Electricity Consumption (TEC)**	Pro 8210: 14.0 kWh/wwk Pro 8210s: 14.0 kWh/wwk Pro 8220: 17.5 kWh/wwk Pro 8220s: 17.4 kWh/wwk
Max. Power Consumption	Pro 8210s/8220s: 3,400 W Pro 8210/8220: 3,600 W
Dimensions (WxDxH)	45" x 35.4" x 45.1" (1,141 x 900 x 1,146 mm)
Weight	Pro 8210s/8220s: 937 lbs. (425 kg) Pro 8210/8220: 904 lbs. (410 kg)
ENERGY STAR EPEAT	Certified Gold Rated
*Via optional paper sources	
**Typical Electricity Consumption by ENERGY STAR program.	

Copier Features (Pro 8210s/8220s only)

Duplex, Simplified Display, Auto Paper Selection, Auto Reduce/Enlarge, Auto Start, Auto Tray Switching, Auto Image Density, User Codes (1,000), Job Programs (25), Electronic Sort/Stack, Image Rotation, Interrupt Copy, User Tools, Job Presets, Book/Serial/Combine Copying, Cover/Chapter/Slip Sheet, Tabs, Sample Copy, Stamps/Numbering, Bates Numbering, Shift/Erase/Margin Adjustment, Customizable Home Screen, Import/Export of Preference Settings, Eco-Friendly Indicator, Power On/Off Timer, Energy Saver, Weekly Timer, External USB Keyboard Support, MFP Browser for Web Image Monitor and @Remote, Copy Reservation (8), A3/DIT Counter, Mixed Originals/ Batch Mode

Security Features

Data Encryption (Address Book, Authentication Password, SSL Communication, S/MIME, IPsec Communication, HDD), User Authentication (Windows*, LDAP, Basic, User Code, 802.1x Wired), Network Protocol On/Off, Mask Type for Data Security, Data Security Unit Option, IP Filtering, Unauthorized Copy/Print Control, Quota Setting, SMTP over SSL, Mandatory Security Information Print (Compulsory Security Stamp)

Printer Specifications

CPU	Intel® Celeron® Processor P4505 - 1.86 GHz
RAM	2 GB
HDD	640 GB (320 x 2) HDD
Max Print Resolution	1200 x 4800 dpi via VCSEL
Standard Interfaces	Ethernet (1000BASE-T/100BASE-TX/10Base-TX), USB 2.0 Type A x 3/Type B, SD slot
Optional Interfaces	IEEE 1284/FCP, IEEE802.11 a/b/g/n, Bluetooth
Network Protocol	TCP/IP (IPv4, IPv6), IPX/SPX
Network Operating Systems	Windows Vista/7/8/8.1/10/Server 2008/Server 2008R2/Server 2012/Server 2012R2; NetWare 6.5; UNIX Sun Solaris 9/10, HP-UX 11.x/11i v2/11i v3, SCO OpenServer 5.0.7/6.0, Red Hat Linux Enterprise V4/V5/V6, IBM AIX 5L V5.3/V6.1/V7.1; Novell Netware 6.5 or later; Citrix XenApp 5.0; Mac OS X 10.5 or later; SAP R/3; NPDS Gateway; IBM iSeries AS/400 using OS/400 Host Print Transform
Print Drivers	Standard: PCL5c, PCL6 (XL), PDF Optional for Pro 8200s only: Adobe PS3, Genuine IPDS
Fonts	PCL: 45 scalable + 13 international; PDF: 136; IPDS: 108 (optional)
Printer Features	Send to Document Server, Sample/Locked/ Hold/Store/Scheduled Print, Store and Print, Layout (N-up), Banner Page Print,

PDF Direct Print, Mail to Print, Classification Code, Bonjour Support, Windows Active Directory Support, DDNS Support, PCL Resident Font Adoption, Tray Parameter Change from Web Image Monitor, 1200 dpi Support, Mobile Driver, WS Print, Wireless LAN Interface Option, Media Direct Print (Print from USB/SD), Auto Job Promotion, AirPrint* Support, Poster Print, WPS (Wi-Fi Protected Setup)

Fiery EB-34 Controller

Efi Platform Configuration	ES200 Pro External
Memory	4 GB
CPU	Intel Processor G850 2.9 Ghz
Host Interface	Ethernet 1000/100/10Base-T x 2
HDD	500 GB
Operating System	Windows 8.1 Professional For Embedded Systems x64
Network Protocol	TCP/IP (IPv4, IPv6), SMB
Printer Description	PS3, PCL 5e, PCL 6
Language	
Max. Resolution	1200 dpi
Fonts	PS3 138, PCL 81
Operation Panel Utilities	Via touch panel display on printer Standard: Efi Driver, Command Workstation, Webtools, Hot Folders Optional: Fiery SeeQuence Impose, Fiery SeeQuence Compose, Image Viewer for Black and White, Efi Spectrophotometer ES-2000, FAC1 Furniture, External Secure HDD Kit

Scanner Specifications (Pro 8210s/8220s only)

Scanning Resolution	Up to 600 dpi (TWAIN: 1200 dpi)
Scan Area	Up to 11.7" x 17" (297 x 432 mm)
Scan Speed (LTR/A4)	Simplex: 120 ipm; Duplex: 220 ipm (B&W and Full-color)
Output Format	Single Page: TIFF/JPEG/PDF/High Compression PDF Multi Page: TIFF/PDF/High Compression PDF
Interface Support	Ethernet (1000BASE-T/100BASE-TX/10Base-T), USB 2.0 Type A, SD card slot, Optional Wireless LAN (IEEE802.11 a/b/g/n)
Authentication	SMTP/POP before SMTP
Scanner Features	Scan to USB/SD, WS Scanner, Scan-to Email/Folder/SMB/FTP/URL/NCP/PDF/A/ Digitally Signed PDF/Searchable PDF, TWAIN Scanning, Scanned File Naming, LDAP Support, Universal Send, Distributed Scan Management, Preview Before Transmission, PDF Encryption, Drop Out Color Send, B&W/FC Photo, B&W/FC Text, Auto Color Selection, Auto Density, Auto Size Detection, Image Rotation, Mixed Size/ SADF/Batch Mode, Reduce and Enlarge, Split Scan, JBIG2 Compression Support

Document Server Specifications

Max. Stored Documents	15,000
Max. Pages per Document	1,000
Max. Stored Pages	15,000
Folder Management	With password, up to 200 personal folders

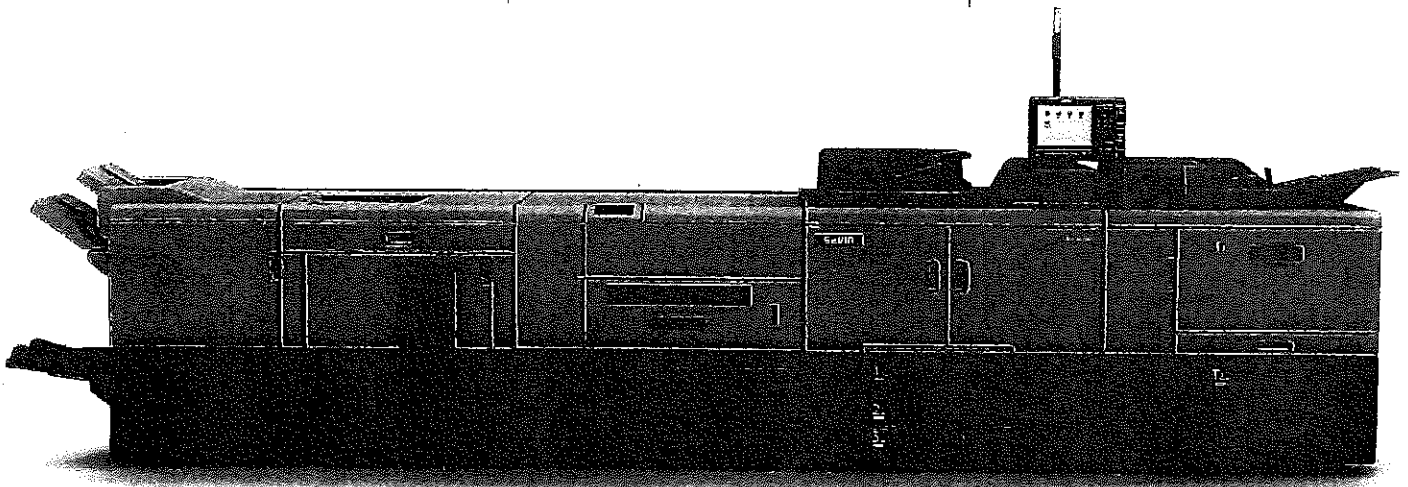

Savin Pro 8210s/8220s/8210/8220

SYSTEM SPECIFICATIONS



Accessories

LCIT RT5100 Vacuum Feed Large Capacity Input Tray	
Paper Capacity	4,400 sheets (2,200 x 2)
Paper Size	A5 (LEF) 5.5" x 8.5" - 13" x 19.2"
Paper Weight	11 lb. Bond - 130 lb. Cover (40 - 350 g/m ²)
Power Consumption	Less than 860 W
Power Supply	100 - 127 V
Dimensions (WxDxH)	41.5" x 28.7" x 39.4" (1,054 x 730 x 1,000 mm)
Weight	Less than 484 lbs. (220 kg)
BUS010 Bridge Unit for LCIT RT5100	
Paper Size	Width: 3.94" to 13" (210 mm to 330.2 mm) Length: 5.5" to 19.2" (428 mm x 487.7 mm)
Paper Weight	11 lb. Bond - 130 lb. Cover (40 - 350 g/m ²)
Power Source	From LCIT RT5100
Dimensions (WxDxH)	13" x 28.7" x 39.4" (330 x 730 x 1,000 mm)
Weight	Less than 132 lbs. (60 kg)
RT5080 A3/DLT Large Capacity Tray (LCT)	
Paper Capacity	4,400 sheets
Paper Size	5.5" x 8.5" - 13" x 19.2"
Paper Weight	11 lb. Bond - 110 lb. Cover (40 - 300 g/m ²)
Dimensions (WxDxH)	34" x 28.7" x 39.4" (865 x 730 x 1,000 mm)
Weight	407 lbs. (185 kg)
RT5070 A4/LT Large Capacity Tray (LCT)	
Paper Capacity	5,000 sheets
Paper Size	5.5" x 8.5" - 8.5" x 11"
Paper Weight	Trays 4 - 5: 14 lb. Bond - 80 lb. Cover (52 - 216 g/m ²) Tray 6: 14 lb. Bond - 60 lb. Cover (52 - 163 g/m ²)
Dimensions (WxDxH)	21.3" x 28.7" x 39.4" (540 x 730 x 1,000 mm)
Weight	233.2 lbs. (106 kg)
BY5010 Multi Bypass Tray	
Paper Capacity	550 sheets
Paper Size	5.5" x 8.5" - 13" x 19.2"
Paper Weight	14 lb. Bond - 80 lb. Cover (52 - 216 g/m ²)
Dimensions (WxDxH)	27.2" x 22.1" x 8.3" (690 x 561 x 210 mm)
Weight	44 lbs. (20 kg)
Multi Bypass Banner Sheet Tray Type S3	
Paper Capacity	500 sheets
Paper Size	5.5" x 8.5" - 13" x 19.2"
Paper Weight	Custom Size: 3.94" x 5.5" - 13" x 27.5"
Dimensions (WxDxH)	14 lb. Bond - 80 lb. Cover (52 - 216 g/m ²) 42.9" x 22.1" x 8.3" (1,090 x 561 x 210 mm) when attached to BY5010
Weight	20.9 lbs. (9.5 kg)
TK5010 A3/DLT Tray Unit	
Paper Capacity	1,000 sheets
Paper Size	Up to 11" x 17"
Dimensions (WxDxH)	19.5" x 20.9" x 6.9" (495 x 530 x 175 mm)
Weight	22 lbs. (10 kg)
CIS030 2 Source Cover Interposer	
Paper Size	5.5" x 8.5" - 13" x 19.2"
Paper Weight	17 lb. Bond - 80 lb. Cover (64 - 216 g/m ²)
Stack Capacity	200 sheets x 2 trays
Dimensions (WxDxH)	21.2" x 28.7" x 50.8" (540 x 730 x 1,290 mm)
Weight	99 lbs. (45 kg)
SIS030 High Capacity Stacker	
Paper Capacity	5,000 sheets (GRA3, A4, LT size); Proof Tray: 250 sheets
Output Jogger	Standard
Rollaway Cart	Standard (optional additional carts available)
Power Consumption	Less than 120 W
Power Supply	120 - 127 V, 50/60 Hz, 2A
Dimensions (WxDxH)	35.4" x 28.7" x 39.8" (900 x 730 x 1,010 mm)
Weight	Stacker: 264 lbs. (120 kg); Roll Away Cart: 33 lbs. (15 kg)
SR5050 3,000-Sheet Finisher with 100-Sheet Stapler Capacity (Proof Tray)	
Capacity (Proof Tray)	250 sheets (8.5" x 11" or smaller) 50 sheets (8.5" x 14" or larger)

Capacity (Shift Tray)	
	8.5" x 11" - 3,000 sheets 8.5" x 14" - 11" x 17" - 1,500 sheets 12" x 18" - 13" x 19.2" - 1,000 sheets
Paper Size	
5.5" x 8.5" - 13" x 19.2"	
Paper Weight	
Proof Tray: 14 lb. Bond - 80 lb. Cover (52 - 216 g/m ²) Shift Tray: 11 lb. Bond - 130 lb. Cover (40 - 350 g/m ²)	
Output Jogger	
Standard	
Staple	
8.5" x 11" - 2 to 100 sheets 8.5" x 14" - 11" x 17" - 2 to 50 sheets	
Staple Position	
Top, Bottom, 2 Staples, Top Slant	
Dimensions (WxDxH)	
39.2" x 28.7" x 44.3" (996 x 730 x 1,126 mm)	
Weight	
246 lbs. (112 kg)	
SR5060 2,500-Sheet Booklet Finisher	
Capacity (Proof Tray) 250 sheets (8.5" x 11" or smaller) 50 sheets (8.5" x 14" or larger)	
Capacity (Shift Tray)	
8.5" x 11" - 2,500 sheets 8.5" x 14" - 11" x 17" - 1,500 sheets 12" x 18" - 13" x 19.2" - 1,000 sheets	
Paper Size	
Proof Tray: 5.5" x 8.5" - 13" x 19.2" Shift Tray: 5.5" x 5.5" - 13" x 19.2"	
Output Jogger	
Standard	
Paper Weight	
Proof Tray: 14 lb. Bond - 80 lb. Cover (52 - 216 g/m ²) Shift Tray: 11 lb. Bond - 130 lb. Cover (40 - 350 g/m ²)	
Staple	
8.5" x 11" - 2 to 100 sheets 8.5" x 14" - 11" x 17" - 2 to 50 sheets	
Staple Position	
Top, Bottom, 2 Staples, Top Slant	
Saddle Stitch Staple	
8.5" x 11" - 13" x 19.2" - 20 sheets; Center 2 Position	
Dimensions (WxDxH)	
39.2" x 28.7" x 44.3" (996 x 730 x 1,126 mm)	
Weight	
246 lbs. (112 kg)	
TR5040 Booklet Trimmer	
Trimming Type	
One Side Edge	
Trimming Capacity	
1 to 20 sheets (2 to 40 pages after folding)	
Paper Size	
Up to 13" x 19.2"	
Stack Capacity	
Up to 60 sets	
Limitless Stack	
Yes	
Dimensions (WxDxH)	
43.9" x 23.3" x 21.8" (1,115 x 591 x 555 mm)	
Weight	
165 lbs. (75 kg)	
FD5020 Multi-Folding Unit	
Folding Type	
Single Sheet Mode: Z-Fold, Half-Fold/Print inside, Half-Fold/Print outside, Letter Fold-In/Print inside, Letter Fold-In/Print outside, Letter Fold-out, Double Parallel/Print inside, Double Parallel/Print outside, Gate-Fold/Print inside, Gate-Fold/Print outside	
Multiple Sheets Mode: Half-Fold/Print inside, Half-Fold/Print outside, Letter Fold-In/Print inside, Letter Fold-In/Print outside, Letter Fold-out	
Paper Size	
Single Sheet Mode: Z folding: 8.5" x 11" - 12" x 18"; Half folding: 8.5" x 11" - 13" x 19.2"; Letter folding: 8.5" x 11" - 13" x 19.2"; Multiple Sheets Mode: Double Parallel folding: 8.5" x 11" - 12" x 18"; Gate folding: 8.5" x 11" - 12" x 18"; Half folding: 8.5" x 11" - 13" x 19.2"; Letter Fold-out: 8.5" x 11"; Letter Fold-in: 8.5" x 11"	
Dimensions (WxDxH)	
18.5" x 28.7" x 39.4" (470 x 730 x 1,000 mm)	
Weight	
203 lbs. (92 kg)	
RB5020 Ring Binder	
Paper Size	
8.5" x 11"/A4	
Paper Weight	
17 lb. Bond - 80 lb. Cover (64 - 216 g/m ²)	
Stack Capacity	
Binding Mode: 11 sets; Punching Mode: 100 sheets	
Ring Bind Capacity	
2 to 100 sheets	
Number of Holes	
LTR - 21, A4 - 23	
Ring Supply	
Black or White, Up to 50 or 100 sheets Supported	
Tab Stock	
34.2" x 28.7" x 39.8" (870 x 730 x 1,010 mm)	
Dimensions (WxDxH)	
34.2" x 28.7" x 39.8" (870 x 730 x 1,010 mm)	
Weight	
308 lbs. (140 kg)	

GB5010 Perfect Binder	
Booklet Size	
Width: 7.9" x 11.7" (201 - 297 mm); Length: 5.5" x 8.5" (140 - 216 mm)	
Booklet Thickness	
Less than 1" (23 mm)	
Body Page Capacity	
200 sheets	
Cutting Directions	
3 Edges, 1 Edge, None	
Paper Weight	
Body Pages: 17 lb. Bond - 60 lb. Cover (64 - 163 g/m ²) Cover Pages: 24 lb. Bond - 110 lb. Cover (90 - 300 g/m ²)	
Stack Capacity/Booklet	
50 sheets; 13; 100 sheets; 7; 200 sheets: 4	
Dimensions (WxDxH)	
42.9" x 31.1" x 54.6" (1,090 x 791 x 1,387 mm)	
Weight	
770 lbs. (350 kg)	
DU5050 Decurl Unit	
Decurl Function	
Three steps pressure adjustment (from operation panel)	
Paper Weight	
11 lb. Bond - 130 lb. Cover (40 - 350 g/m ²)	
Dimensions (WxDxH)	
2.8" x 20" x 7.1" (71 x 509 x 181 mm)	
Weight	
11 lbs. (5 kg)	
HC3500 Ploclmatic High Capacity Interposer	
Number of Trays	
2	
Paper Size	
4.7" x 8.3" - 13.8" x 26" (120 x 210 mm - 350 x 660 mm)	
Paper Weight	
18 lb. Bond - 130 lb. Cover (65 - 350 g/m ²)	
Paper Capacity	
3,500 sheets	
Power Supply	
115 V, 60 Hz	
Dimensions (WxDxH)	
47" x 28" x 43" (1,200 x 700 x 1,100 mm)	
Weight	
551 lbs. (250 kg)	
PBM350/PBM500 Ploclmatic Booklet Maker	
Paper Size	
8.5" x 11" - 12" x 18"	
Paper Weight	
17 lb. Bond - 100 lb. Cover (64 - 300 g/m ²)	
Set Size	
PBM350 - 2-35 sheets (20 lb. Bond/ 80 g/m ²) PBM500 - 2-50 sheets (20 lb. Bond/ 80 g/m ²)	
Power Supply	
115 V, 60 Hz	
Dimensions (WxDxH)	
55.9" x 35.4" x 27.6" (1,420 x 970 x 700 mm)	
Weight	
297 lbs. (135 kg)	
GBC StreamPunch Ultra	
Punched Paper Sizes	
5.5" x 8.5", 8.5" x 11", 8.5" x 14", 11" x 17"	
Punched Media Weight	
20 lb. Bond - 110 lb. Cover (up to 300 g/m ²)	
Range	
Tab Punching Yes	
"Two-Up" Punching Yes	
Power Supply	
115 V, 60 Hz	
Dimensions (WxDxH)	
17.5" x 28.7" x 39.4" (445 x 730 x 1,000 mm)	
Weight	
220 lbs. (100 kg)	
RPP Interface Box Type S3 (For third-party finishing peripherals only)	
Dimensions (WxDxH)	
10.4" x 9.9" x 5.3" (265 x 253 x 136 mm)	
Weight	
1.2 lbs. (0.55 kg)	

Additional Accessories

IPDS Unit Type S8 for Printer Models, PostScript3 Unit Type S8 for Printer Models, PostScript3 Unit Type S7 for MFP Models, IPDS Unit Type S7 for MFP Models, ADF Double Feed Detection, Transit Pass Unit for Perfect Binder Type S1, Cover Interposer Tray for Perfect Binder Type S1, Multi Bypass Attachment Kit for RT5100 LCIT Type S3, Roll-Away Cart Type S010, Punch Unit PU5020, Optional Counter Interface Unit Type M12, Copy Connector Type S260, IEEE 802.11a/b/g/n Interface Unit Type M2, OCR Unit Type M2, Copy Data Security Unit Type G, File Format Converter Type E, IEEE 1284 Interface Board Type A

Supply Yields

Toner	82,000 per bottle*
Drum	2,500K images/unit
Developer	860K prints/bag

*Based on 6% chart of Ricoh A4 LEF test sheet under normal operating conditions.

For maximum performance and yield we recommend using genuine Ricoh parts and supplies.

Specifications subject to change without notice.

www.savin.com

Ricoh USA, Inc., 70 Valley Stream Parkway, Malvern, PA 19355, 1-877-472-8460
Savin® and the Savin logo are registered trademarks of Ricoh USA, Inc. Ricoh® and the Ricoh logo are registered trademarks of Ricoh Company Ltd. All other trademarks are the property of their respective owners. ©2016 Ricoh USA, Inc. All rights reserved. Some products and services are offered by Ricoh USA, Inc. and its affiliates. The content of this document, and the appearance, features and specifications of Savin products and services are subject to change from time to time without notice. Products are shown with optional features. While care has been taken to ensure the accuracy of this information, Ricoh makes no representation or warranties about the accuracy, completeness or adequacy of the information contained herein, and shall not be liable for any errors or omissions in these materials. Actual results will vary depending upon use of the products and services, and the conditions and factors affecting performance. The only warranties for Savin products and services are as set forth in the express warranty statements accompanying them.

Environmental Responsibility

Atlantic - Tomorrows Office has a long history as a proactive leader in developing and implementing environmentally safe products, systems, and management policies.

Environmentally Safe Products

EPA Energy Star® Program:

All proposed units are participating members of the Environmental Protection Agency ("EPA") Energy Star® Program for copiers and facsimiles. Energy Star® compliant units automatically turn-off after a period of inactivity, thus ensuring the copier is off during weekends and nights. The automatic shut-off features can result in more than a 60% reduction in annual electricity costs.

Ozone Generation:

All copiers using the electrostatic principle generate ozone. All proposed units utilize state-of-the-art technology and dedication to research and developments have minimized the system-inherent ozone. Any ozone still generated is eliminated almost completely by efficient ozone filters.

Noise:

All proposed units are designed to contribute to a low-noise environment. Energy Saver features put the unit in standby mode, reducing noise and saving energy.

Environmentally Safe Systems

The following proposed equipment and supplies have been implemented in furtherance of each manufacturer's environmentally responsible policies:

Paper Recycling:

All proposed units are manufactured to accept specific grades of recycled paper. There are many grades of recycled paper that do not comply with the recommendations of copier manufacturers. Some recycled papers have extremely short fibers, higher resin content, and generate higher dust particles. Some poor paper quality can affect the wear and tear on copier machines, resulting in more frequent miss-feeds or service calls. Atlantic can recommend the correct grade and quality of recycled paper for a specific copier.

Packaging Materials & Accessories:

Atlantic consistently explores new ways to use recycled packing materials such as boxes, pallets, and packing. For example, wooden crates are being replaced with 100% recyclable cardboard. All proposed copier stands utilize a hi-solids baking enamel with low a Volatile Organic Compounds emission.

Toner Cartridge Recycling Program:

As part of an ongoing commitment, Atlantic offers a Toner Cartridge Recycling Program for our proposed units. Under this program, the firm can return their empty cartridge for recycling using a prepaid mailing label contained in the box.

Atlantic's Commitment to the Environment

Supply recycling is just one example of Atlantic's commitment to the environment. Atlantic's "Go Green" programs continually strive to minimize the environmental impact in manufacturing, during use and in recycling of the products components at end-of-life.

Union County School References

Clark Board of Education

Springfield Board of Education

Garwood Board of Education

Mountainside Board of Education

Summit Board of Education

Winfield Board of Education

Union County Vo Tech

Rahway Board Of Education

Hillside Board of Education

Kenilworth Board of Education

Cranford Board of Education

Union County College

Westfield Board Of Education