



TOWNSHIP OF UNION PUBLIC SCHOOLS

March 18, 2025

SUPERINTENDENT'S REPORT



TUPS SCHOOL PRESENTATIONS - BUDGET PRESENTATION - U HIGHLIGHTS - STUDENT HIGHLIGHTS - HCES UPDATES - CURRICULUM UPDATES - HIB REPORTS

SCHOOL PRESENTATIONS

MRS. KELLY PIANO
PRINCIPAL

MRS. CHRISTINE HENDRICKSON
PTA PRESIDENT

SCHOOL PRESENTATIONS

MRS. LAURA DAMATO
PRINCIPAL

MRS. LAURIE ROOF
VICE PRINCIPAL

Mrs. Lisa McMahon
PTA President

**CONGRATULATIONS TO JEFFERSON
WHO WAS SELECTED TO PARTICIPATE
AS A SHOWCASE SCHOOL IN THIS
YEAR'S NJ PBSIS FORUM.**



PBSIS – Positive Behavior Support in Schools

- PBSIS creates a safe, positive, supportive and effective learning environment for all students by focusing on teaching and reinforcing positive behaviors and using proactive strategies to address problematic behaviors.
- PBSIS aims to improve social, emotional, and academic outcomes for all students, including those with disabilities and those from underrepresented groups.
- PBSIS emphasizes preventing problems before they occur by teaching positive behaviors and creating a positive school climate.

2024 - 2025 PTA Led Activities

- Ice Cream Social (Meet and Greet)
- Welcome back staff breakfast & Holiday Luncheon
- School Spirit Fundraisers (throughout the year)
- Mrs. Fields & Gertrude Hawk
- Pretzel & Pajama Days
- Theater Week
- Dine and Donate (Master Pizza, Outback, Five Guys)
- Family Paint Night
- Dave and Busters Family Fun Night
- Holiday Shop
- Scholastic Bookfairs
- Family Bingo Night
- Educational Assemblies
- VIP Dance

Upcoming:

- Teacher Appreciation Week
- Clothing Drive
- Family Fun Night (Bowling - Linden Lanes)
- Plant Sale
- Graduate Lawn Sign Sale
- Pool Party



IN THE U - HIGHLIGHTS

**GOVERNOR'S EDUCATOR
OF THE YEAR & SERVICE
PROFESSIONAL**

**LESLIE NIGRO &
FATIMA DECORTE**



LESLIE & FATIMA

**TUPS
SUPERINTENDENT'S
PARENT ADVISORY
BOARD (SPAB)
STRENGTHENING
COMMUNICATION
BETWEEN PARENTS &
DISTRICT LEADERS!**



AYANA

BOARD STUDENT LIASONS

**AYANA JOSAPHAT
(MARCH)**

**ALAN MOWLE
(APRIL)**

**MARIELLA GARCIA
(MAY)**



ALAN



MARIELLA



It's All About U

IN THE U - HIGHLIGHTS

WINTER TRACK

CALEB DUVELSON IS THE
2025 GROUP 4 SHOT PUT
STATE CHAMP

GABRIELE RICHARDS, ESHY
CHRISTIAN, LIYANNA
MUSCAT AND MIKARLA
POTUONDO ARE GROUP 4
GIRLS 4X200 STATE
CHAMPIONS



CALEB



LIYANNA, MIKARLA, GABRIELE, ESHY,

BOWLING

SAMAD ALIM TOOK 3RD
PLACE IN THE UNION
COUNTY TOURNAMENT.



PAUL

WRESTLING

19-9
UCT -MOUNTAIN DIVISION
CHAMPS
SECTIONAL SEMIS N2 G5
3RD IN DISTRICTS
SEVEN WENT TO REGIONS
ARIEL AZEREDO
MADE IT TO STATES

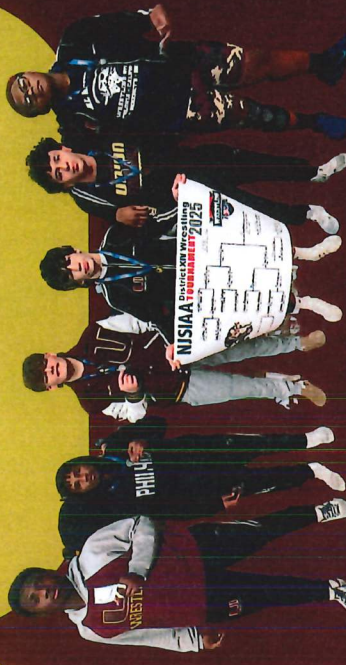

MARK, GABE, NICKY, ARIEL, AARON, O'BRIGHT

Black History Month Projects Around the U



IN THE U - STUDENT HIGHLIGHTS



FEBRUARY
ATHLETES OF THE MONTH

ARIEL AZEREDO
WRESTLING
NISIAA STATE QUALIFIER

UNION

RYU JUVATE
SWIMMING
STATE WILD CARD QUALIFIER

CALEB DUVELSON
SHOT PUT
GROUP 4 CHAMPION

Ariel Azeredo is shown in a wrestling pose, wearing a black singlet and white shoes. Ryu Juvate is shown in a swimming cap and goggles, floating in the water. Caleb Duvelson is shown in a shot put pose, wearing a blue singlet and white shoes.

IN THE U - STUDENT HIGHLIGHTS

Union High School recognizes the
2025 Unsung Hero Damian Koziol



At Hannah U, Mrs. Reguinho & Mrs.
Clarke's kindergarten class, celebrated
the 100th day of school in style!



It's All About U

2025-2026 REVENUE FORECAST BUDGET IMPACT!

Preliminary budget

Anticipated
Federal Funding
Loss
\$877,095

Medicaid
Reimbursement
Lost \$ 200,751

Enrollment
Adjustment
Loss
\$1,147,723

Pre-K
Lost
\$337,000

*Equalization
Aid Lost
\$4,790,677

Total State Aid
Lost
\$1,734,137

All Revenue in
FY 26 we have
\$1,036,640 less
than the FY25
Total Lost \$3,959,706



93% of the Operating Budget



\$122,552,76 = 72%

Salaries & Health Benefits

\$10,591,067 = 6.2%

Transportation Contracted Services...

\$17,824,296 = 10.4%
Tuitions

\$7,725,429 = 4.5%
Related Services (Special Education, ESS, etc.)

2025-2026 TUPS MAJOR EXPENDITURES



It's All About U

HCES UPDATE

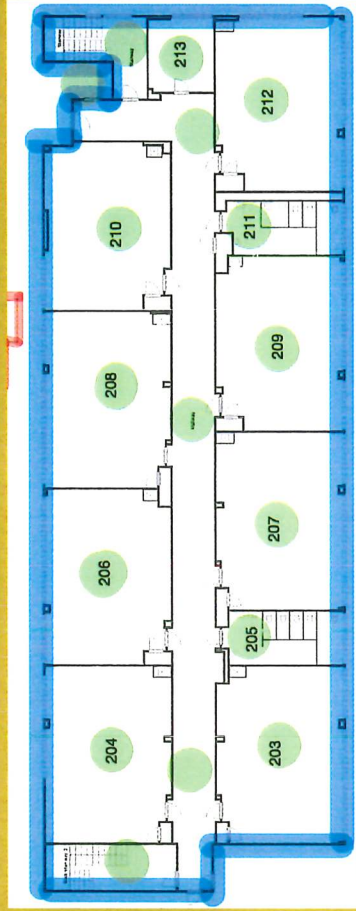
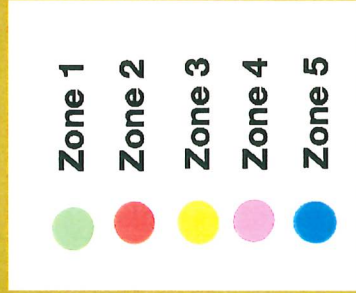
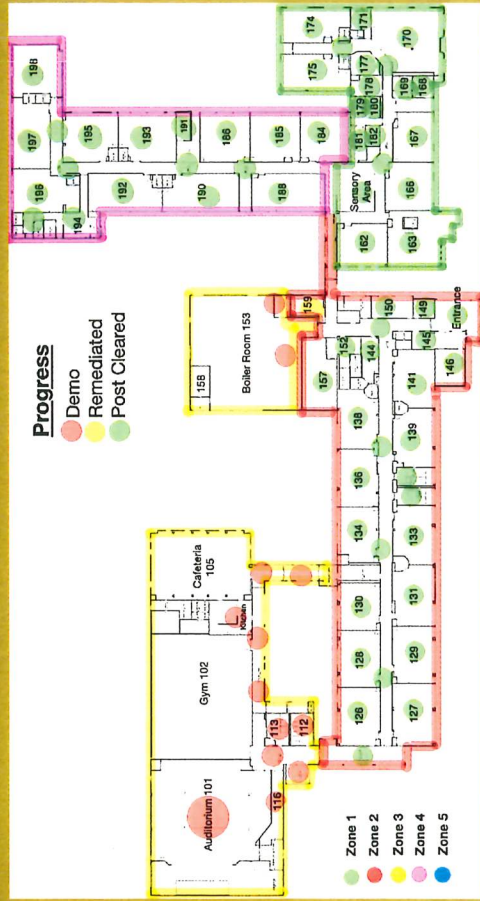

HCES UPDATE

Finishing Demo Zone 3



Encapsulation



Contents Storage



HCES UPDATE

Finishing Demo Zone 3



What is Next!

Masonry: Brick Pointing
Sealing & Waterproofing
Address Window Issues

Sheetrock

Ceiling Tiles

Framing

Bathroom Updates

CURRICULUM UPDATE

Reading Grades K-4

Reading:

Assessment Window 1 to Window 2
Focus on phonological awareness,
phonics, vocabulary, and
comprehension

Increased the number of students
performing at grade level

Strengthened Phonological Awareness &
Phonics Skills

Improved Comprehension in Grades 2-4

Access i-Ready at home
to see their student's
individual progress

English -

https://docs.google.com/document/d/1qTD1vxoT7MH11mIWmugLHTd3wftBaB5uSXVt5_9Zmao/edit?t?usp=sharing

Spanish -

<https://docs.google.com/document/d/1prhUO12OzxnoArBQjLDaUqVAN-zrvs7MdXBZV5VG96bg/edit?usp=sharing>

CURRICULUM UPDATE

Math Grades K-4

Math:

Assessment Window 1 to Window 2

Focus on number and operations, algebraic thinking, measurement and data, and geometry.

Overall, math performance has improved significantly, especially in number and operations and algebraic thinking.

Increased Number of Students Performing at Grade Level

Strengthened Number & Operations Skills
Improved Algebraic Thinking in Grade 3 & 4

Access i-Ready at home to see their student's individual progress continued

Haitian Creole - Haitian Creole -

https://docs.google.com/document/d/1V_fNixzrG0QaiKmWJkCjWmyjzmJN2A-ObQKPC3x5hXE/edit?usp=sharing

Portuguese -

<https://docs.google.com/document/d/15tjIS87rSvvsQydgZ4zo7xxZ5OE9OA8SyMrN7mhB9s/edit?usp=sharing>

An overview of i-Ready and how we use it in district

Portuguese -

<https://docs.google.com/document/d/15tjIS87rSvvsQydgZ4zo7xxZ5OE9OA8SyMrN7mhB9s/edit?usp=sharing>

IT'S ALL ABOUT U!

Our Monthly Newsletter Focusing on the School Community

STRENGTHENING COMMUNITY TIES: MEET & GREET

WITH PTA & BOARD OF EDUCATION

In an effort to foster collaboration and strengthen community ties, local PTA leadership, Board of Education members, town officials, and Township of Union central office leaders recently gathered for a Meet and Greet event. This informal gathering provided an opportunity for open dialogue, relationship-building, and a shared commitment to supporting students and families. Held at Cliff's restaurant, the event allowed attendees to discuss key educational initiatives, town-wide developments, and ways to enhance student experiences. PTA representatives emphasized the importance of parent engagement in education, while Board of Education members shared insights into upcoming policies and programs. Town officials spoke about the importance of continued collaboration between schools and local government. Attendees expressed enthusiasm for future joint initiatives, reinforcing the belief that strong partnerships between families, educators, and local leaders contribute to student success and community growth. The event concluded with a renewed sense of teamwork and a shared vision for the future of education in Union.



STAY IN TOUCH

- TUPE Website
- TUPE Instagram
- Student Athletics Schedule
- TUPE High Impact Training Site

Would you like to have your department/school featured in our next issue? Click here to submit or email iscoco22a@twpunionschools.org P. 1

Student Farmer Frontline

What's Up With TUPS?

🌟 Congratulations to the UHS TOP 25 of the Class of 2025! 🌟
 Your hard work, dedication, and perseverance have earned you this incredible achievement. We are so proud of you and can't wait to see all the amazing things you will accomplish in the future!

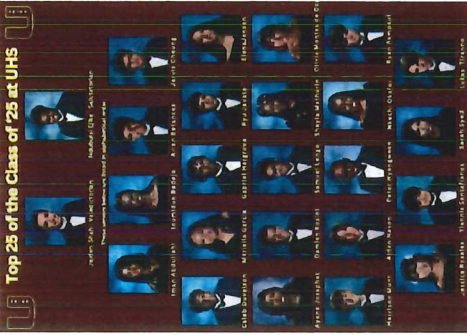

Jalden Valdictorian

"Being named UHS Valdictorian is an incredible honor that reflects years of dedication, perseverance, and curiosity. It's more than just grades-it's the late nights I've overcome, the hard work I've put in, and the unwavering support of my teachers, family, and friends, and it's an honor that is shared with all of those at UHS who have worked so tirelessly toward their goals. As I move forward, I'm excited to see how these experiences will shape the next chapter of my life."

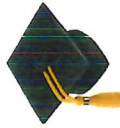

Peter Top 25

"It feels more than exciting to be considered as the Top 25 of my class. Being known as one of the highest performing students in Union High School tells me that all the hard work that I have done in the past 4 years has paid off tremendously. The hard work in question was that I always stuck to my goals, and I never let anything get in my way. I really enjoyed this place as much as some sort of motivation for other students that through this mindset and with a bunch of support from your family, friends, and teachers, you can see yourself in my shoes and be proud of yourself once that hard work leads to great accomplishments in the future. I thank everyone who supported me and can't wait for what's ahead!"

Nidubisi Saluatorian

"It feels great to be the Saluatorian. I feel like the title represents all the work I've done in the Freshman year. The sleepless nights and hangovers I had to work through in the end, helping me to get into good colleges for myself. I will work just as hard in college."

Marriella Top 25

"It feels surreal to be among the top 25 Years of hard work and dedication have finally paid off. I'm incredibly proud of my teachers, peers, and family for their unwavering support throughout this journey."

STRATEGIC PLAN

Strategic Planning Needs Assessment

Total Responses
Record Count
2,201

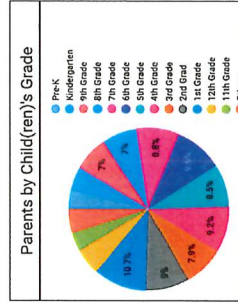
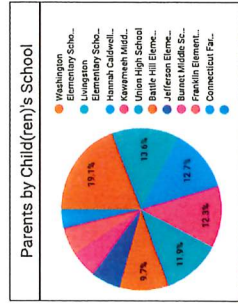
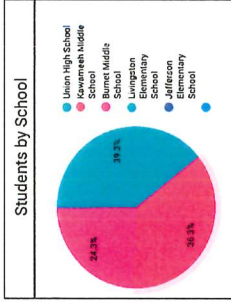
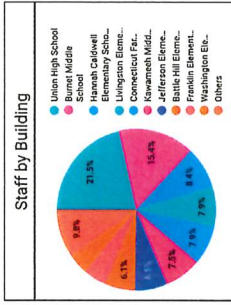
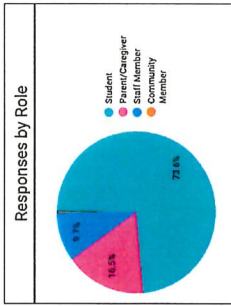

Township of Union Public Schools
STRATEGIC PLAN
 Information Update
 February 28, 2025



It's All About U

Help Shape the Future of Our Schools!

The Strategic Planning Needs Assessment Survey is designed to gather valuable insights from our TUPS school community, including students, parents/caregivers, staff members, and community members. Your feedback is crucial in helping us identify strengths, areas for improvement, and emerging needs for our school district. By participating in this survey, you will contribute to identifying the future needs of our educational programs, resources, and initiatives.

Thank you for your participation,
 Dr. Gerry Benaguista
 Superintendent of Schools &
 The Township of Union Board of Education



PLEASE SCAN THE QR CODE TO TAKE OUR STRATEGIC PLANNING NEEDS ASSESSMENT SURVEY



It's All About U

HARASSMENT, INTIMIDATION, AND BULLYING (HIB) HIB INCIDENTS AFFIRMED CASES

REPORTING PERIOD

FEBRUARY 19, 2025 TO MARCH 11, 2025

FOUNDED 8	NOT FOUNDED/ INCONCLUSIVE 3
UHS 4 BHER 1	KMS 2
BMS 1 KMS 1	HCES 1
CFES 1	

HARASSMENT, INTIMIDATION, AND BULLYING (HIB) HIB INCIDENTS TO REPORT

REPORTING PERIOD
MARCH 12, 2025 TO MARCH 18, 2025

FOUNDED 5	NOT FOUNDED/ INCONCLUSIVE 6
UHS 3	FES 3
BMS 2	UHS 1
	HCES 1

BOE RESOLUTION HIGHLIGHTS

THE BAR - FAMILY WORKSHOP EVENT
APPROVE UP THE BARD TO PROVIDE A
FAMILY WORKSHOP EVENT ENTITLED
"LEARNING TOGETHER: SIMPLE, FUN
WAYS TO BOOST YOUR CHILD'S SUCCESS"
FOR MULTILINGUAL LEARNERS

UNION

It's All About U